

CONTEGO

OO COO

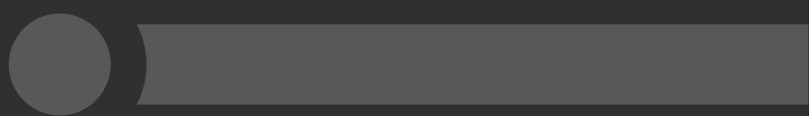

NTEGGO



Inspirirajte se
i stvorimo dom
Vaših snova...



CONTEGO

MODERNI DEKORI



Jedan od najzujbudljivijih aspekata dizajniranja namještaja je odabir dekora.

Upravo zato smo pripremili bogat izbor novih i modernih dekora iverica, radnih ploča i zidnih obloga, kako biste mogli kreirati savršen namještaj po svojoj želji.

No, odabir pravog dekora može biti izazovan, posebno ako niste sigurni što biste željeli ili ako želite kombinirati više dekora. Kako biste lakše donijeli odluku, pozivamo Vas da posjetite naš showroom i istražite našu ponudu.

DRVNI CENTAR



Naš drvni centar Vam nudi preko 200 različitih dekora iverice, svjetski poznatih brendova Yildiz Entegre, Vario Kapak, Egger, itd.

U ponudi također imamo i visokokvalitetne akrilne ploče u svim bojama, te različite radne kuhinjske ploče.

Drvni centar firme opremljen je sa četiri proizvodne linije i modernim visokokvalitetnim strojevima svjetski poznatog proizvođača HOLZHER.



OKOVI ZA NAMJEŠTAJ

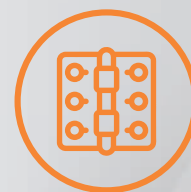

Naš veleprodajni lager obuhvata preko 1000 različitih proizvoda, iz oblasti okova za proizvodnju namještaja.

Sve narudžbe dostavljamo na adresu kupca brзом poštom u roku od 72h. Proizvodi iz naše ponude podliježu prikladnim garancijskim rokovima. Ukoliko Vas zanima više o našoj ponudi, asortimanu, te novitetima i akcijskim ponudama, naš terenski komercijalista Vam stoji na raspolaganju.

Očekujemo Vaš poziv i posjetu!



PVC NOGE ZA NAMJEŠTAJ



ŠIFRA ARTIKLA	OPIS ARTIKLA	J.M.	
NPC1015	Noga, PVC, 10-15cm, crna	Kom.	252
NPC15	Noga, PVC, 15cm, crna	Kom.	250



euroflex
by kapsan

ŠIFRA ARTIKLA	OPIS ARTIKLA	J.M.	
DDC_SET	Držač drvene cokle 10/1	Set.	10
DC	Držač PVC cokle	Kom.	10



ŠIFRA ARTIKLA	OPIS ARTIKLA	J.M.	
NPC40100	Noga, PVC, Ø40, h-100mm	Kom.	100
NPC40150	Noga, PVC, Ø40, h-150mm	Kom.	80
NPC40200	Noga, PVC, Ø40, h-200mm	Kom.	60



ŠIFRA ARTIKLA	OPIS ARTIKLA	J.M.	
DDC40	Držač drvene cokle, za nogu φ 40	Kom.	10
DC40	Držač PVC cokle, za nogu φ 40	Kom.	10



METALNE NOGE ZA NAMJEŠTAJ



ŠIFRA ARTIKLA	OPIS ARTIKLA	J.M.	
NS00650	Noga, metalna, sa regulatorom visine, saten, Ø47mm x 50mm	Kom.	100
NS00680	Noga, metalna, sa regulatorom visine, saten, Ø47mm x 80mm	Kom.	100
NS006100	Noga, metalna, sa regulatorom visine, saten, Ø47mm x 100mm	Kom.	50



ŠIFRA ARTIKLA	OPIS ARTIKLA	J.M.	
NA01150	Noga, aluminij, kvadratna, 40x40x50mm	Kom.	200
NA011100	Noga, aluminij, kvadratna, 40x40x100mm	Kom.	200
NA01150C	Noga, crna, kvadratna, 40x40x50mm	Kom.	200
NA011100C	Noga, crna, kvadratna, 40x40x100mm	Kom.	200



ŠIFRA ARTIKLA	OPIS ARTIKLA	J.M.	
NS01050	Noga, metalna, sa regulatorom visine, saten, Ø40mm x 50mm	Kom.	100
NS010100	Noga, metalna, sa regulatorom visine, saten, Ø40mm x 100mm	Kom.	100



ŠIFRA ARTIKLA	OPIS ARTIKLA	J.M.	
NC00650	Noga, metalna, sa regulatorom visine, crna, Ø47mm x 50mm	Kom.	100
NC00680	Noga, metalna, sa regulatorom visine, crna, Ø47mm x 80mm	Kom.	100
NC006100	Noga, metalna, sa regulatorom visine, crna, Ø47mm x 100mm	Kom.	50



ŠIFRA ARTIKLA	OPIS ARTIKLA	J.M.	
NA01250	Noga, aluminij, Ø40, h-50mm	Kom.	200
NA012100	Noga, aluminij, Ø40, h-100mm	Kom.	200
NA01250C	Noga, crna, Ø40, h-50mm	Kom.	200
NA012100C	Noga, crna, Ø40, h-100mm	Kom.	200



ŠIFRA ARTIKLA	OPIS ARTIKLA	J.M.	
KAP100	Noga za namještaj, Ø38mm, h-50mm	Kom.	100
KAP101	Noga za namještaj, Ø38mm, h-70mm	Kom.	100
KAP102	Noga za namještaj, Ø38mm, h-100mm	Kom.	100
KAP100C	Noga za namještaj, Ø38mm, h-50mm, crna	Kom.	100
KAP101C	Noga za namještaj, Ø38mm, h-70mm, crna	Kom.	100
KAP102C	Noga za namještaj, Ø38mm, h-100mm, crna	Kom.	100
KAP100B	Noga za namještaj, Ø38mm, h-50mm, bijela	Kom.	100
KAP101B	Noga za namještaj, Ø38mm, h-70mm, bijela	Kom.	100
KAP102B	Noga za namještaj, Ø38mm, h-100mm, bijela	Kom.	100



ŠIFRA ARTIKLA	OPIS ARTIKLA	J.M.	
KAP137B	Noga za namještaj, 25x25mm, H100mm, bijela	Kom.	100
KAP138B	Noga za namještaj, 25x25mm, H150mm, bijela	Kom.	100
KAP137C	Noga za namještaj, 25x25mm, H100mm, crna	Kom.	100
KAP138C	Noga za namještaj, 25x25mm, H150mm, crna	Kom.	100

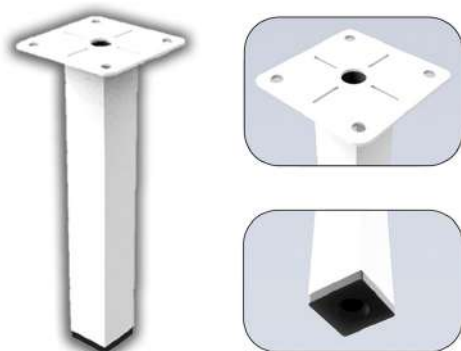

ŠIFRA ARTIKLA	OPIS ARTIKLA	J.M.	
KAP136MK	Noga za namještaj, Ø42mm, h-50mm	Kom.	100
KAP107	Noga za namještaj, Ø42mm, h-70mm	Kom.	100
KAP108	Noga za namještaj, Ø42mm, h-100mm	Kom.	100
KAP136C	Noga za namještaj, Ø42mm, h-50mm, crna	Kom.	100
KAP107C	Noga za namještaj, Ø42mm, h-70mm, crna	Kom.	100
KAP108C	Noga za namještaj, Ø42mm, h-100mm, crna	Kom.	100
KAP136MB	Noga za namještaj, Ø42mm, h-50mm, bijela	Kom.	100
KAP107B	Noga za namještaj, Ø42mm, h-70mm, bijela	Kom.	100
KAP108B	Noga za namještaj, Ø42mm, h-100mm, bijela	Kom.	100



ŠIFRA ARTIKLA	OPIS ARTIKLA	J.M.	
KAP139B	Noga za namještaj, Ø30mm, H100mm, bijela	Kom.	100
KAP140B	Noga za namještaj, Ø30mm, H150mm, bijela	Kom.	100
KAP139C	Noga za namještaj, Ø30mm, H100mm, crna	Kom.	100
KAP140C	Noga za namještaj, Ø30mm, H150mm, crna	Kom.	100

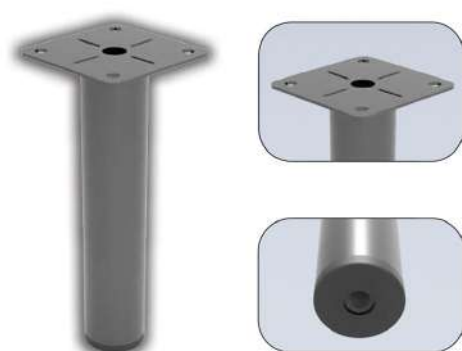

ŠIFRA ARTIKLA	OPIS ARTIKLA	J.M.	
NS710	Noga, metalna, saten, Ø60, h-710mm	Kom.	4
NC710	Noga, metalna, crna, Ø60, h-710mm	Kom.	4
NS810	Noga, metalna, saten, Ø60, h-810mm	Kom.	4
NC810	Noga, metalna, crna, Ø60, h-810mm	Kom.	4

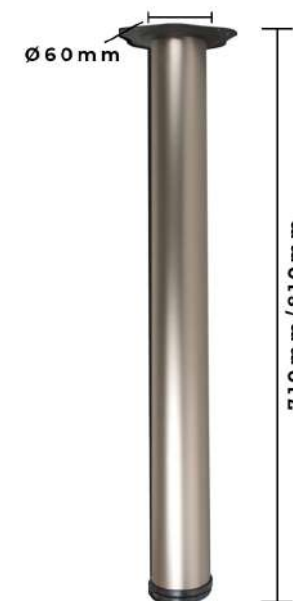

ŠIFRA ARTIKLA	OPIS ARTIKLA	J.M.	
NTC30	Noga, trokutasta, crna, 30mm	Kom.	300

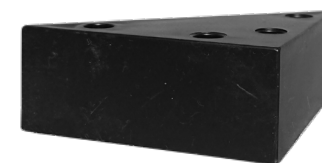

ŠIFRA ARTIKLA	OPIS ARTIKLA	J.M.	
NM6	Nogaica, M6X30mm, s navojem, bijela	Kom.	100
NM6C	Nogaica M6X30mm, s navojem, crna	Kom.	100



ŠIFRA ARTIKLA	OPIS ARTIKLA	J.M.	
ND710	Noga za stol, h-710mm "DIVA"	Kom.	4
ND510	Noga za stol, h-510mm "DIVA"	Kom.	4
ND310	Noga za stol, h-310mm "DIVA"	Kom.	4
ND210	Noga za stol, h-210mm "DIVA"	Kom.	4



ŠIFRA ARTIKLA	OPIS ARTIKLA	J.M.	
NI50MK	Noga MONARCH, h-50mm	Kom.	120
NI80MK	Noga MONARCH, h-80mm	Kom.	120
NI100MK	Noga MONARCH, h-100mm	Kom.	120



ŠIFRA ARTIKLA	OPIS ARTIKLA	J.M.	
NSE2-B	Noga - podloška sa dva eksera - bijela	Kom.	100
NSE2-S	Noga - podloška sa dva eksera - smeđa	Kom.	100



ŠIFRA ARTIKLA	OPIS ARTIKLA	J.M.	
NSE1-B	Noga - podloška sa jednim ekserom - bijela	Kom.	100
NSE1-S	Noga - podloška sa jednim ekserom - smeđa	Kom.	100



ŠIFRA ARTIKLA	OPIS ARTIKLA	J.M.	
S001	Stopica, PVC, siva	Kom.	500

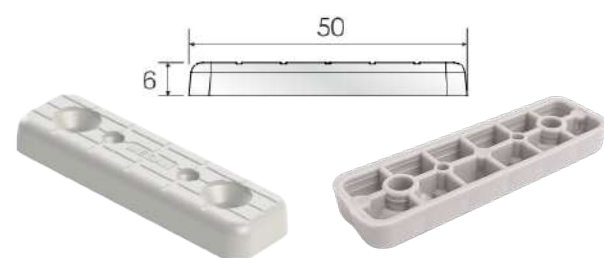

ŠIFRA ARTIKLA	OPIS ARTIKLA	J.M.	
PKNC	Plastična kajla za nivelisanje 20x200mm, crna	Kom.	100
PKNB	Plastična kajla za nivelisanje 20x200mm, bijela	Kom.	100

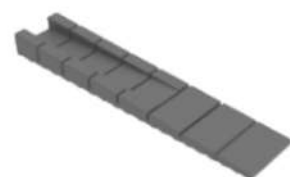

NOSAČI ŠANKA

ŠIFRA ARTIKLA	OPIS ARTIKLA	J.M.	PAKOVANJE
KAP130	Nosač šanka sa postoljem, Ø42mm, 250mm	Kom.	50



ŠIFRA ARTIKLA	OPIS ARTIKLA	J.M.	
NS3H	Noge za stol, Mod.3, 2/1, 30x50	Par	1



ŠIFRA ARTIKLA	OPIS ARTIKLA	J.M.	
NS2H	Noge za stol, Mod.2, 2/1, 30x50	Par	1







KOTAČI ZA NAMJEŠTAJ

ŠIFRA ARTIKLA	OPIS ARTIKLA	J.M.	
KP03440	Kotač, PVC, Ø40mm, sa ravnom pločicom, h=5,5cm	Kom.	4
KP03450	Kotač, PVC, Ø50mm, sa ravnom pločicom, h=6,5cm	Kom.	4

ŠIFRA ARTIKLA	OPIS ARTIKLA	J.M.	
KP03540	Kotač, PVC, Ø40mm, sa ravnom pločicom i kočnicom, h=5,5cm	Kom.	4
KP03550	Kotač, PVC, Ø50mm, sa ravnom pločicom i kočnicom, h=6,5cm	Kom.	4



ŠIFRA ARTIKLA	OPIS ARTIKLA	J.M.	
KS2	Kotač silikonski, bez kočnice, h=5,08cm	Kom.	100
KSK2	Kotač silikonski, sa kočnicom, h=5,08cm	Kom.	100

ŠIFRA ARTIKLA	OPIS ARTIKLA	J.M.	
KS1	Kotač silikonski, bez kočnice, h=3,81cm	Kom.	100
KSK1	Kotač silikonski, sa kočnicom, h=3,81cm	Kom.	100



ŠIFRA ARTIKLA	OPIS ARTIKLA	J.M.	
KSK5	Kotač metalni, sa kočnicom, h=6cm	Kom.	50



ŠIFRA ARTIKLA	OPIS ARTIKLA	J.M.	
KSK6	Kotač metalni, sa kočnicom, h=7cm	Kom.	50



ŠIFRA ARTIKLA	OPIS ARTIKLA	J.M.	
KBK5	Kotač metalni, bez kočnice, h=6cm	Kom.	50



ŠIFRA ARTIKLA	OPIS ARTIKLA	J.M.	
KBK6	Kotač metalni, bez kočnice, h=7cm	Kom.	50



ŠIFRA ARTIKLA	OPIS ARTIKLA	J.M.	
KV036	Kotač, sa ravnom vilicom, h=32,5mm	Kom.	50



ŠIFRA ARTIKLA	OPIS ARTIKLA	J.M.	
KV036G	Kotač s ravnom vilicom, gumeni točkić	Kom.	50





ŠIFRA ARTIKLA	OPIS ARTIKLA	J.M.	
L4S	Pult lajsna PVC, 4m, metalik siva	Kom.	30
L4A	Pult lajsna PVC, 4m, antracit	Kom.	30
L4C	Pult lajsna PVC, 4m, crna VS	Kom.	30
L4CM	Pult lajsna PVC, 4m, crna mat	Kom.	30
L4B	Pult lajsna PVC, 4m, bijela VS	Kom.	30
L4BM	Pult lajsna PVC, 4m, mat bijela	Kom.	30
L4I	Pult lajsna PVC, 4m, inox	Kom.	30
L4AL	Pult lajsna PVC, 4m, aluminijum mat	Kom.	30

ŠIFRA ARTIKLA	OPIS ARTIKLA	J.M.	
KLS	Set kutnika za lajsnu, 4/1, metalik siva	Set.	50
KLA	Set kutnika za lajsnu, 4/1, antracit	Set.	50
KLC	Set kutnika za lajsnu, 4/1, crna	Set.	50
KLB	Set kutnika za lajsnu, 4/1, bijela	Set.	50
KLI	Set kutnika za lajsnu, 4/1, INOX	Set.	50

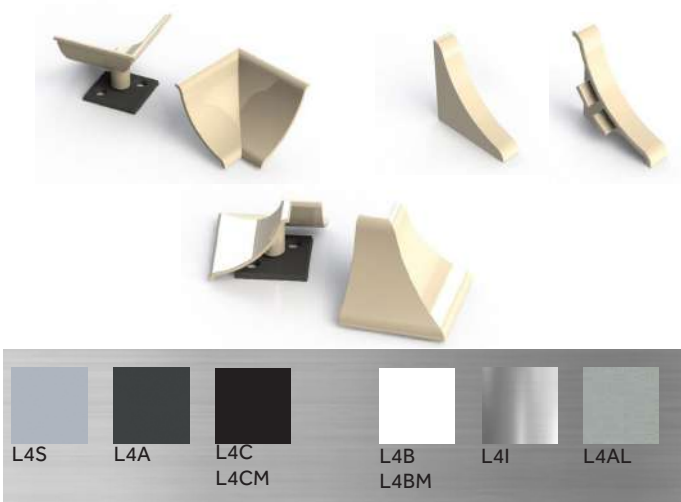

ŠIFRA ARTIKLA	OPIS ARTIKLA	J.M.	
LS4S	Pult lajsna PVC, S model, 4m, metalik siva	Kom.	20
LS4A	Pult lajsna PVC, S model, 4m, antracit	Kom.	20
LS4I	Pult lajsna PVC, S model, 4m, inox	Kom.	20
LS4AL	Pult lajsna PVC, S model, 4m, aluminijum mat	Kom.	20



ŠIFRA ARTIKLA	OPIS ARTIKLA	J.M.	
LT4S	Pult lajsna, T model, 4000mm, metalik siva, PVC	Kom.	40



ŠIFRA ARTIKLA	OPIS ARTIKLA	J.M.	
LM4S	Pult lajsna PVC, mini sistem, 4m, siva	Kom.	40
LSMA	Pult lajsna PVC, mini sistem, 4m, antracit	Kom.	40
LM4I	Pult lajsna PVC, mini sistem, 4m, inox	Kom.	40
LM4B	Pult lajsna PVC, mini sistem, 4m, bijela	Kom.	40
LM4C	Pult lajsna PVC, mini sistem, 4m, crna	Kom.	40
LM4AL	Pult lajsna PVC, mini sistem, 4m, aluminijum mat	Kom.	40



ŠIFRA ARTIKLA	OPIS ARTIKLA	J.M.	
KLSS	Set kutnika za lajsnu, S model, 4/1, siva	Set.	50
KLSA	Set kutnika za lajsnu, S model, 4/1, antracit	Set.	50
KLSI	Set kutnika za lajsnu, S model, 4/1, INOX	Set.	50

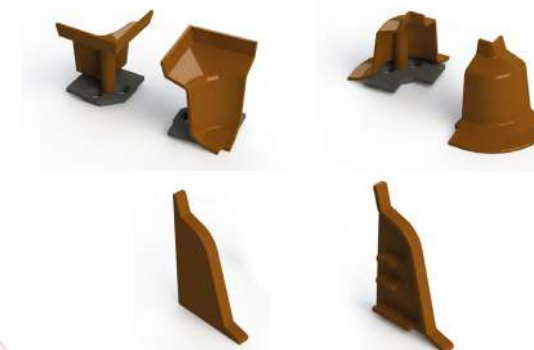

ŠIFRA ARTIKLA	OPIS ARTIKLA	J.M.	
KLTS	Set kutnika za lajsnu, T model, 4/1	Set.	50

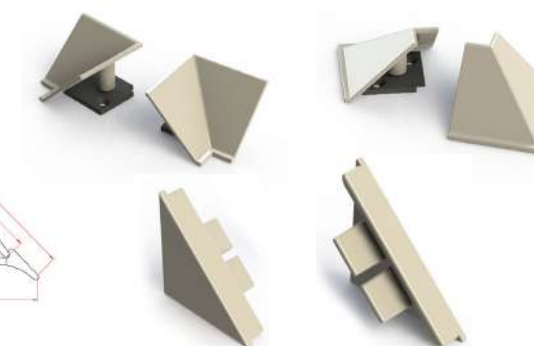

ŠIFRA ARTIKLA	OPIS ARTIKLA	J.M.	
KLMS-H	Set kutnika za lajsnu, mini sistem, 4/1, metalik siva	Set.	50
KLMA-H	Set kutnika za lajsnu, mini sistem, 4/1, antracit	Set.	50
KLMI-H	Set kutnika za lajsnu, mini sistem, 4/1, INOX	Set.	50
KLMB-H	Set kutnika za lajsnu, mini sistem, 4/1, bijela	Set.	50
KLMC-H	Set kutnika za lajsnu, mini sistem, 4/1, crna	Set.	50

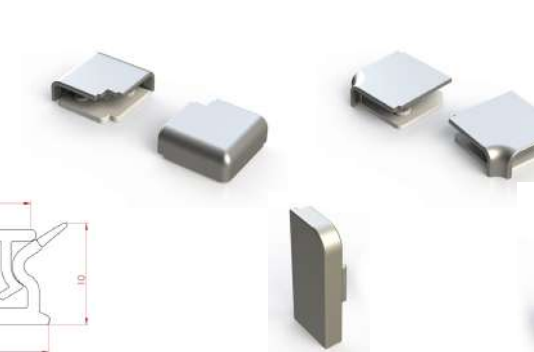

ŠIFRA ARTIKLA	OPIS ARTIKLA	J.M.	PAKOVANJE
---------------	--------------	------	-----------

ASLK604 Alu sastavna lajsna za kut, 60cmx4cm Kom. 100

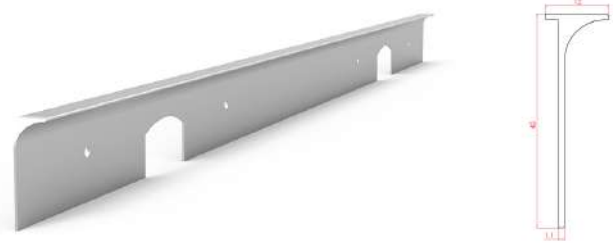

ŠIFRA ARTIKLA	OPIS ARTIKLA	J.M.	PAKOVANJE
---------------	--------------	------	-----------

ASL604 Alu sastavna lajsna, 60cmx4cm Kom. 100

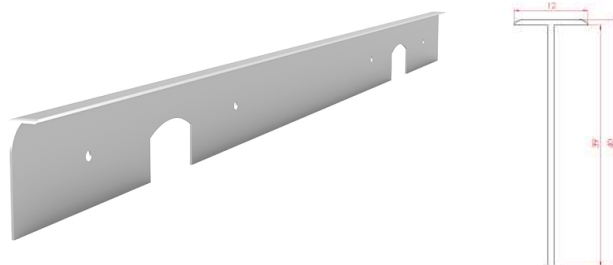

ŠIFRA ARTIKLA	OPIS ARTIKLA	J.M.	PAKOVANJE
---------------	--------------	------	-----------

AZL604 Alu završna lajsna, 60cmx4cm Kom. 100

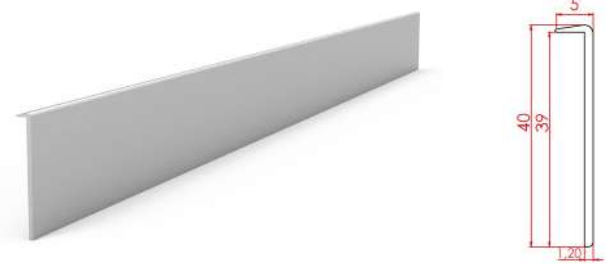

ŠIFRA ARTIKLA	OPIS ARTIKLA	J.M.	PAKOVANJE
---------------	--------------	------	-----------

VRP65 Vijak za spajanje radnih ploča, 65mm Kom. 100



ŠIFRA ARTIKLA	OPIS ARTIKLA	J.M.	PAKOVANJE
---------------	--------------	------	-----------

AL4160-BM Aluminijska završna lajsna, 38x600mm, crna mat Par 25

AL4160-W Aluminijska završna lajsna, 38x600mm, bijela Par 25

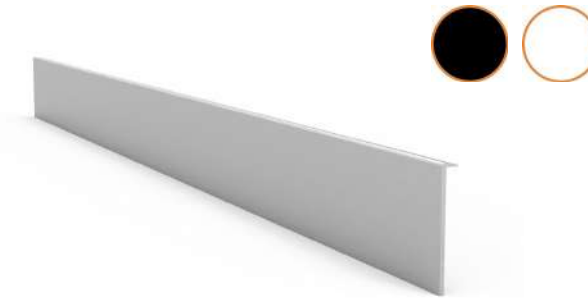

ŠIFRA ARTIKLA	OPIS ARTIKLA	J.M.	PAKOVANJE
---------------	--------------	------	-----------

AL4260-BM Aluminijska kutna sastavna lajsna, 38x600mm, crna mat Kom. 25

AL4260-W Aluminijska kutna sastavna lajsna, 38x600mm, bijela Kom. 25

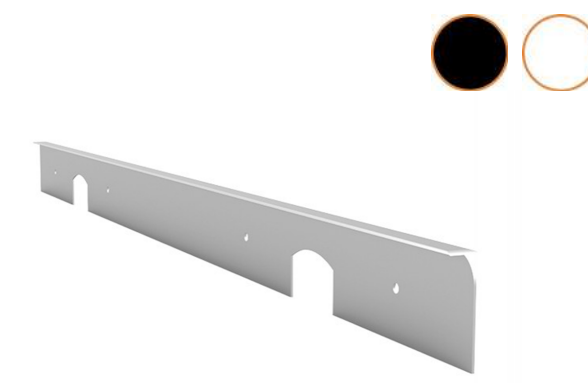

ŠIFRA ARTIKLA	OPIS ARTIKLA	J.M.	PAKOVANJE
---------------	--------------	------	-----------

AL4360-BM Aluminijska sastavna lajsna, 38x600mm, crna mat Kom. 25

AL4360-W Aluminijska sastavna lajsna, 38x600mm, bijela Kom. 25







**KUHINJSKE
PVC COKLE**

ŠIFRA ARTIKLA	OPIS ARTIKLA	J.M.	
C10S	Cokla PVC, h-10cm, L-4m, metalic siva	Kom.	15
C10A	Cokla PVC, h-10cm, L-4m, antracit	Kom.	15
C10CM	Cokla PVC, h-10cm, L-4m, crna mat	Kom.	15
C10C	Cokla PVC, h-10cm, L-4m, crna VS	Kom.	15
C10B	Cokla PVC, h-10cm, L-4m, bijela VS	Kom.	15
C10BM	Cokla PVC, h-10cm, L-4m, bijela mat	Kom.	15
C10I	Cokla PVC, h-10cm, L-4m, inox	Kom.	15

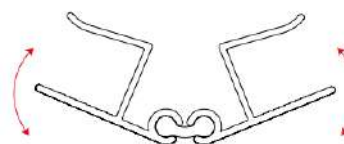
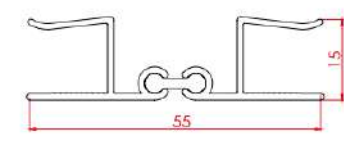
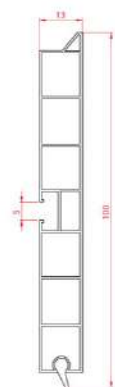
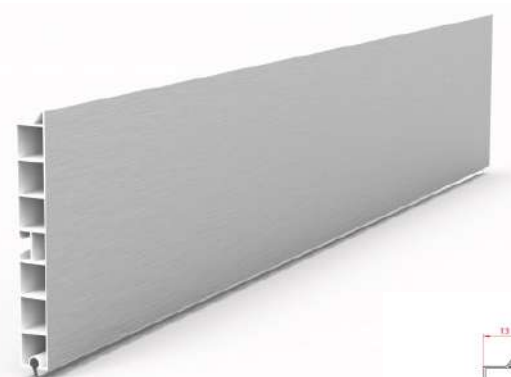
ŠIFRA ARTIKLA	OPIS ARTIKLA	J.M.	
KC10S	Kutnik cokle, 10cm, metalic siva	Kom.	50
KC10A	Kutnik cokle, 10cm, antracit	Kom.	50
KC10CM	Kutnik cokle, 10cm, crna mat	Kom.	50
KC10C	Kutnik cokle, 10cm, crna VS	Kom.	50
KC10B	Kutnik cokle, 10cm, bijela VS	Kom.	50
KC10BM	Kutnik cokle, 10cm, bijela mat	Kom.	50
KC10I	Kutnik cokle, 10cm, inox	Kom.	50



euromflex
by kapsan

ŠIFRA ARTIKLA	OPIS ARTIKLA	J.M.	
C15S	Cokla PVC, h-15cm, L-4m, metalic siva	Kom.	15
C15A	Cokla PVC, h-15cm, L-4m, antracit	Kom.	15
C15CM	Cokla PVC, h-15cm, L-4m, crna mat	Kom.	15
C15C	Cokla PVC, h-15cm, L-4m, crna VS	Kom.	15
C15B	Cokla PVC, h-15cm, L-4m, bijela VS	Kom.	15
C15BM	Cokla PVC, h-15cm, L-4m, bijela mat	Kom.	15
C15I	Cokla PVC, h-15cm, L-4m, inox	Kom.	15

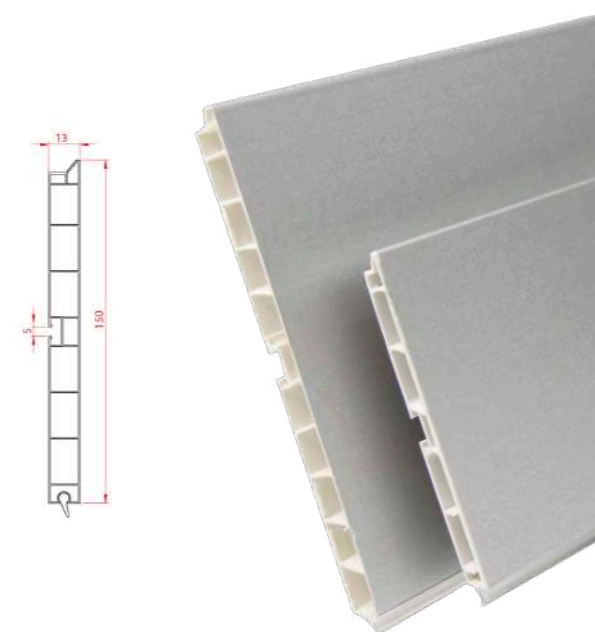

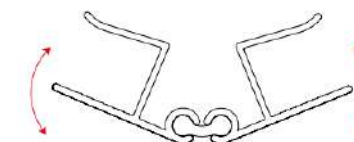
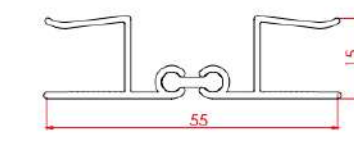
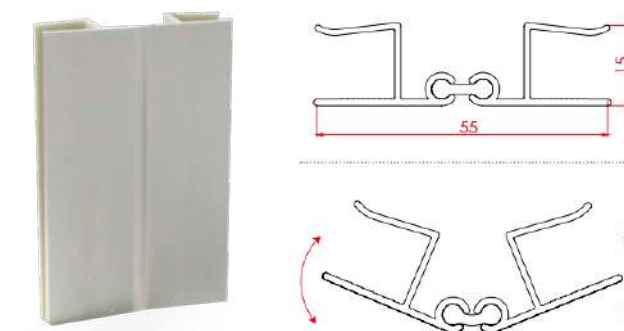

ŠIFRA ARTIKLA	OPIS ARTIKLA	J.M.	
KC15S	Kutnik cokle, 15cm, metalic siva	Kom.	50
KC15A	Kutnik cokle, 15cm, antracit	Kom.	50
KC15CM	Kutnik cokle, 15cm, crna mat	Kom.	50
KC15C	Kutnik cokle, 15cm, crna VS	Kom.	50
KC15B	Kutnik cokle, 15cm, bijela VS	Kom.	50
KC15BM	Kutnik cokle, 15cm, bijela mat	Kom.	50
KC15I	Kutnik cokle, 15cm, inox	Kom.	50

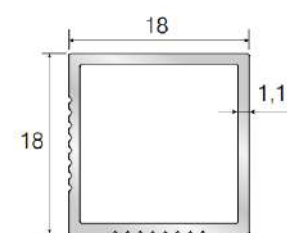

VEZNA LETVA ZA KORPUS

ŠIFRA ARTIKLA	OPIS ARTIKLA	J.M.	
VL1818	Vezna letva za korpus, 18 x 18mm	m.	90m



ŠIFRA ARTIKLA	OPIS ARTIKLA	J.M.	
DVL1	Držači vezne letve	Kom.	100





TITAN
2in1

**VODILICE
ZA LADICE**



ŠIFRA ARTIKLA	OPIS ARTIKLA	J.M.	
TV250GT	Teleskopska kuglična vodilica h45, L-250mm, sa ublaživačem, TITAN	Par.	15
TV300GT	Teleskopska kuglična vodilica h45, L-300mm, sa ublaživačem, TITAN	Par.	15
TV350GT	Teleskopska kuglična vodilica h45, L-350mm, sa ublaživačem, TITAN	Par.	15
TV400GT	Teleskopska kuglična vodilica h45, L-400mm, sa ublaživačem, TITAN	Par.	15
TV450GT	Teleskopska kuglična vodilica h45, L-450mm, sa ublaživačem, TITAN	Par.	15
TV500GT	Teleskopska kuglična vodilica h45, L-500mm, sa ublaživačem, TITAN	Par.	15
TV550GT	Teleskopska kuglična vodilica h45, L-550mm, sa ublaživačem, TITAN	Par.	15
TV600GT	Teleskopska kuglična vodilica h45, L-600mm, sa ublaživačem, TITAN	Par.	15

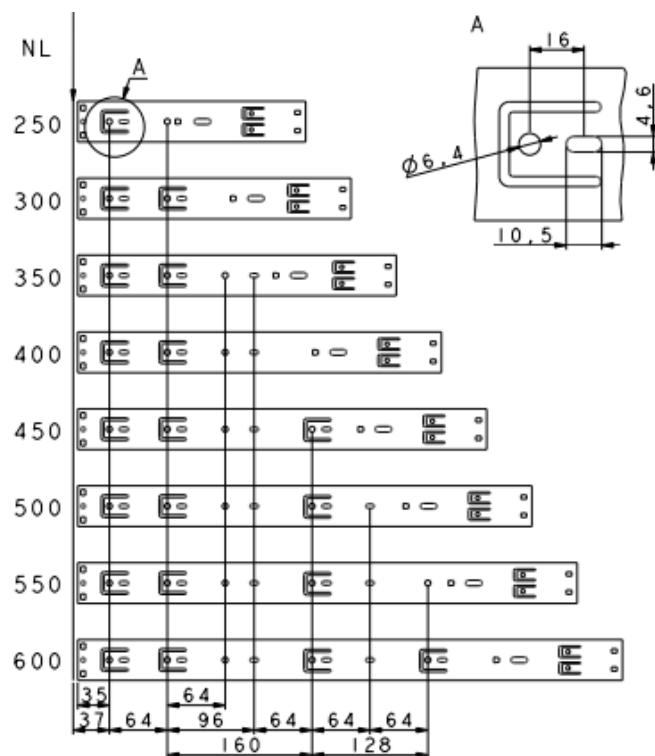

ŠIFRA ARTIKLA	OPIS ARTIKLA	J.M.	
TV250G	Teleskopska kuglična vodilica h45, L-250mm, 1,2x1,2x1,5	Par.	15
TV300G	Teleskopska kuglična vodilica h45, L-300mm, 1,2x1,2x1,5	Par.	15
TV350G	Teleskopska kuglična vodilica h45, L-350mm, 1,2x1,2x1,5	Par.	15
TV400G	Teleskopska kuglična vodilica h45, L-400mm, 1,2x1,2x1,5	Par.	15
TV450G	Teleskopska kuglična vodilica h45, L-450mm, 1,2x1,2x1,5	Par.	15
TV500G	Teleskopska kuglična vodilica h45, L-500mm, 1,2x1,2x1,5	Par.	15
TV550G	Teleskopska kuglična vodilica h45, L-550mm, 1,2x1,2x1,5	Par.	15
TV600G	Teleskopska kuglična vodilica h45, L-600mm, 1,2x1,2x1,5	Par.	15

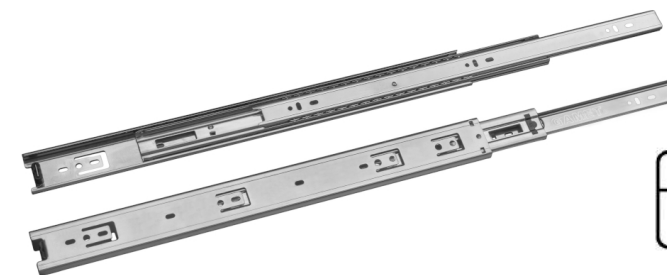
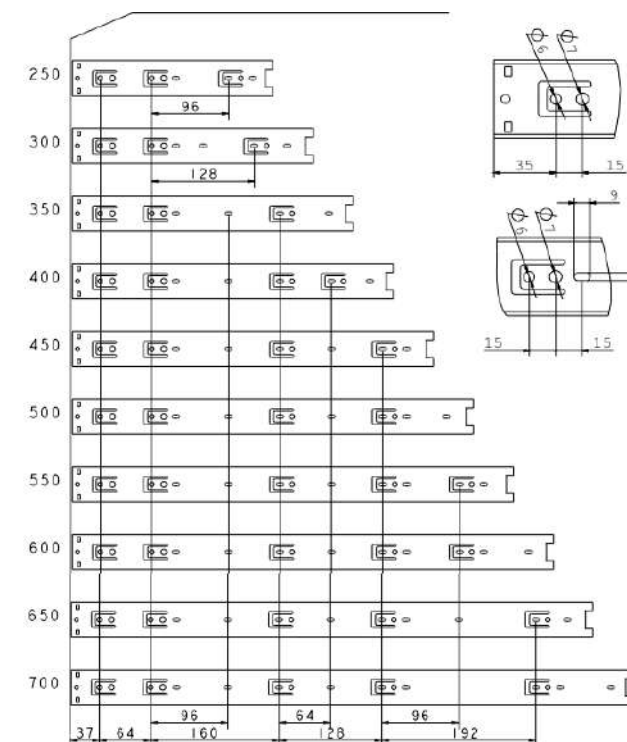

ŠIFRA ARTIKLA	OPIS ARTIKLA	J.M.	
VLB250G	Vodilica ladica, bijela, 250mm	Par.	25
VLB300G	Vodilica ladica, bijela, 300mm	Par.	25
VLB350G	Vodilica ladica, bijela, 350mm	Par.	25
VLB400G	Vodilica ladica, bijela, 400mm	Par.	25
VLB450G	Vodilica ladica, bijela, 450mm	Par.	25
VLB500G	Vodilica ladica, bijela, 500mm	Par.	25
VLB550G	Vodilica ladica, bijela, 550mm	Par.	25
VLB600G	Vodilica ladica, bijela, 600mm	Par.	25

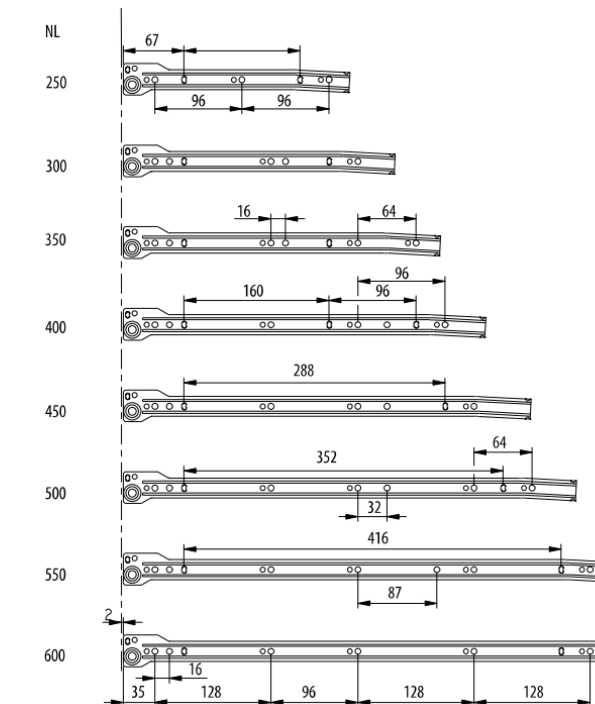

GAMET BOX



ŠIFRA ARTIKLA	OPIS ARTIKLA	J.M.	
BOX350	Gamet Box, h-100mm, L-350mm	Par.	6
BOX400	Gamet Box, h-100mm, L-400mm	Par.	6
BOX450	Gamet Box, h-100mm, L-450mm	Par.	6
BOX500	Gamet Box, h-100mm, L-500mm	Par.	6

ŠIFRA ARTIKLA	OPIS ARTIKLA	J.M.	
BOX350-1	Gamet Box, h-154mm, L-350mm, s 1 relingom	Par.	6
BOX400-1	Gamet Box, h-154mm, L-400mm, s 1 relingom	Par.	6
BOX450-1	Gamet Box, h-154mm, L-450mm, s 1 relingom	Par.	6
BOX500-1	Gamet Box, h-154mm, L-500mm, s 1 relingom	Par.	6

ŠIFRA ARTIKLA	OPIS ARTIKLA	J.M.	
BOX350-2	Gamet Box, h-218mm, L-350mm, s 2 relinga	Par.	6
BOX400-2	Gamet Box, h-218mm, L-400mm, s 2 relinga	Par.	6
BOX450-2	Gamet Box, h-218mm, L-450mm, s 2 relinga	Par.	6
BOX500-2	Gamet Box, h-218mm, L-500mm, s 2 relinga	Par.	6

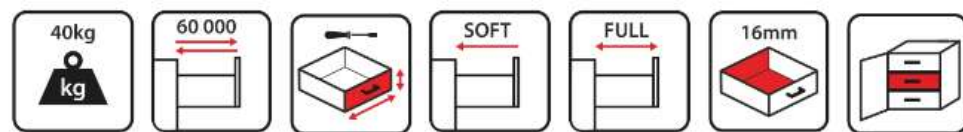

METAL BOX - GAMET

ŠIFRA ARTIKLA	OPIS ARTIKLA	J.M.	
MB86300	Metal box, h-86mm, L-300mm	Par.	10
MB86350	Metal box, h-86mm, L-350mm	Par.	10
MB86400	Metal box, h-86mm, L-400mm	Par.	10
MB86450	Metal box, h-86mm, L-450mm	Par.	10
MB86500	Metal box, h-86mm, L-500mm	Par.	10

ŠIFRA ARTIKLA	OPIS ARTIKLA	J.M.	
MB150300	Metal box, h-150mm, L-300mm	Par.	10
MB150350	Metal box, h-150mm, L-350mm	Par.	10
MB150400	Metal box, h-150mm, L-400mm	Par.	10
MB150450	Metal box, h-150mm, L-450mm	Par.	10
MB150500	Metal box, h-150mm, L-500mm	Par.	10



CRNE TELESKOPSKE VODILICE

ŠIFRA ARTIKLA	OPIS ARTIKLA	J.M.	
TV300ASC	Teleskopska kuglična vodilica sa ublaživačem, 300mm, AOSITE, 1.2x1.2x1.5mm, 45mm, crna	Par.	15
TV350ASC	Teleskopska kuglična vodilica sa ublaživačem, 350mm, AOSITE, 1.2x1.2x1.5mm, 45mm, crna	Par.	15
TV400ASC	Teleskopska kuglična vodilica sa ublaživačem, 400mm, AOSITE, 1.2x1.2x1.5mm, 45mm, crna	Par.	15
TV450ASC	Teleskopska kuglična vodilica sa ublaživačem, 450mm, AOSITE, 1.2x1.2x1.5mm, 45mm, crna	Par.	15
TV500ASC	Teleskopska kuglična vodilica sa ublaživačem, 500mm, AOSITE, 1.2x1.2x1.5mm, 45mm, crna	Par.	15

ŠIFRA ARTIKLA	OPIS ARTIKLA	J.M.	
TV300ACP	Teleskopska kuglična vodilica PUSH OPEN, 300mm, AOSITE, 1.2x1.2x1.5mm, 45mm, crna	Par.	15
TV350ACP	Teleskopska kuglična vodilica PUSH OPEN, 350mm, AOSITE, 1.2x1.2x1.5mm, 45mm, crna	Par.	15
TV400ACP	Teleskopska kuglična vodilica PUSH OPEN, 400mm, AOSITE, 1.2x1.2x1.5mm, 45mm, crna	Par.	15
TV450ACP	Teleskopska kuglična vodilica PUSH OPEN, 450mm, AOSITE, 1.2x1.2x1.5mm, 45mm, crna	Par.	15
TV500ACP	Teleskopska kuglična vodilica PUSH OPEN, 500mm, AOSITE, 1.2x1.2x1.5mm, 45mm, crna	Par.	15



TELESKOPSKE I
SKRIVENE VODILICE



ŠIFRA ARTIKLA	OPIS ARTIKLA	J.M.	
TV300AS	Teleskopska kuglična vodilica, h-45, L-300mm, 1.2x1.2x1.5, AOSITE, sa ublaživačem	Par.	15
TV350AS	Teleskopska kuglična vodilica, h-45, L-350mm, 1.2x1.2x1.5, AOSITE, sa ublaživačem	Par.	15
TV400AS	Teleskopska kuglična vodilica, h-45, L-400mm, 1.2x1.2x1.5, AOSITE, sa ublaživačem	Par.	15
TV450AS	Teleskopska kuglična vodilica, h-45, L-450mm, 1.2x1.2x1.5, AOSITE, sa ublaživačem	Par.	15
TV500AS	Teleskopska kuglična vodilica, h-45, L-500mm, 1.2x1.2x1.5, AOSITE, sa ublaživačem	Par.	15



ŠIFRA ARTIKLA	OPIS ARTIKLA	J.M.	
TV300A	Teleskopska kuglična vodilica, h-45, L-300mm, AOSITE	Par.	15
TV350A	Teleskopska kuglična vodilica, h-45, L-350mm, AOSITE	Par.	15
TV400A	Teleskopska kuglična vodilica, h-45, L-400mm, AOSITE	Par.	15
TV450A	Teleskopska kuglična vodilica, h-45, L-450mm, AOSITE	Par.	15
TV500A	Teleskopska kuglična vodilica, h-45, L-500mm, AOSITE	Par.	15



ŠIFRA ARTIKLA	OPIS ARTIKLA	J.M.	
VSD300	Vodilica skrivena, L-300mm, djelimična izvlaka, za 18mm	Par.	10
VSD350	Vodilica skrivena, L-350mm, djelimična izvlaka, za 18mm	Par.	10
VSD400	Vodilica skrivena, L-400mm, djelimična izvlaka, za 18mm	Par.	10
VSD450	Vodilica skrivena, L-450mm, djelimična izvlaka, za 18mm	Par.	10
VSD500	Vodilica skrivena, L-500mm, djelimična izvlaka, za 18mm	Par.	10

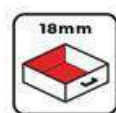

ŠIFRA ARTIKLA	OPIS ARTIKLA	J.M.	
VSP300G	Vodilica skrivena, L-300mm, puna izvlaka, za 18mm, GAMET	Par.	10
VSP350G	Vodilica skrivena, L-350mm, puna izvlaka, za 18mm, GAMET	Par.	10
VSP400G	Vodilica skrivena, L-400mm, puna izvlaka, za 18mm, GAMET	Par.	10
VSP450G	Vodilica skrivena, L-450mm, puna izvlaka, za 18mm, GAMET	Par.	10
VSP500G	Vodilica skrivena, L-500mm, puna izvlaka, za 18mm, GAMET	Par.	10

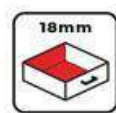

AOSITE BOX

ŠIFRA ARTIKLA	OPIS ARTIKLA	J.M.	
ABOX350	AOSITE Box L-350mm, h-84mm, bijela boja	Par.	6
ABOX400	AOSITE Box L-400mm, h-84mm, bijela boja	Par.	6
ABOX450	AOSITE Box L-450mm, h-84mm, bijela boja	Par.	6
ABOX500	AOSITE Box L-500mm, h-84mm, bijela boja	Par.	6

ŠIFRA ARTIKLA	OPIS ARTIKLA	J.M.	
ABOX350-1	AOSITE Box L-350mm, h-135mm, bijela boja, sa jednim kvadratim relingom	Par.	6
ABOX400-1	AOSITE Box L-400mm, h-135mm, bijela boja, sa jednim kvadratim relingom	Par.	6
ABOX450-1	AOSITE Box L-450mm, h-135mm, bijela boja, sa jednom kvadratim relingom	Par.	6
ABOX500-1	AOSITE Box L-500mm, h-135mm, bijela boja, sa jednim kvadratim relingom	Par.	6

ŠIFRA ARTIKLA	OPIS ARTIKLA	J.M.	
ABOX350-2	AOSITE Box L-350mm, h-199mm, bijela boja, sa dva kvadrata relingom	Par.	6
ABOX400-2	AOSITE Box L-400mm, h-199mm, bijela boja, sa dva kvadrata relingom	Par.	6
ABOX450-2	AOSITE Box L-450mm, h-199mm, bijela boja, sa dva kvadrata relingom	Par.	6
ABOX500-2	AOSITE Box L-500mm, h-199mm, bijela boja, sa dva kvadrata relingom	Par.	6

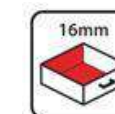



SLIM BOX - AOSITE

ŠIFRA ARTIKLA	OPIS ARTIKLA	J.M.	
SB300-1	Slim box, l-300mm, h-86mm, bijela boja / AOSITE	Set.	6
SB350-1	Slim box, l-350mm, h-86mm, bijela boja / AOSITE	Set.	6
SB400-1	Slim box, l-400mm, h-86mm, bijela boja / AOSITE	Set.	6
SB450-1	Slim box, l-450mm, h-86mm, bijela boja / AOSITE	Set.	6
SB500-1	Slim box, l-500mm, h-86mm, bijela boja / AOSITE	Set.	6

ŠIFRA ARTIKLA	OPIS ARTIKLA	J.M.	
SB300-2	Slim box, l-300mm, h-167mm, bijela boja / AOSITE	Set.	6
SB350-2	Slim box, l-350mm, h-167mm, bijela boja / AOSITE	Set.	6
SB400-2	Slim box, l-400mm, h-167mm, bijela boja / AOSITE	Set.	6
SB450-2	Slim box, l-450mm, h-167mm, bijela boja / AOSITE	Set.	6
SB500-2	Slim box, l-500mm, h-167mm, bijela boja / AOSITE	Set.	6

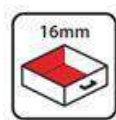
ŠIFRA ARTIKLA	OPIS ARTIKLA	J.M.	
SB300-2	Slim box, l-300mm, h-199mm, bijela boja / AOSITE	Set.	6
SB350-2	Slim box, l-350mm, h-199mm, bijela boja / AOSITE	Set.	6
SB400-2	Slim box, l-400mm, h-199mm, bijela boja / AOSITE	Set.	6
SB450-3	Slim box, l-450mm, h-199mm, bijela boja / AOSITE	Set.	6
SB500-3	Slim box, l-500mm, h-199mm, bijela boja / AOSITE	Set.	6



ŠIFRA ARTIKLA	OPIS ARTIKLA	J.M.	
C80120000	Šina za vješanje kuhinjskih elemenata, L-2000mm, pocinčana	Kom.	10



ŠIFRA ARTIKLA	OPIS ARTIKLA	J.M.	
S2CAM	Šina za vješanje kuhinjskih elemenata, L-2000mm, CAMAR	Kom.	10



CAMAR® the art of innovation

ŠIFRA ARTIKLA	OPIS ARTIKLA	J.M.	
NV040	Nosač visećeg elementa, bijeli, L + D, univerzalni, 2 kom.	Par.	100



ŠIFRA ARTIKLA	OPIS ARTIKLA	J.M.	
NV042D	Nosač visećih elemenata, CAMAR, desni	Kom.	200
NV042L	Nosač visećih elemenata, CAMAR, lijevi	Kom.	200
PN01D	Poklopac nosača visećih elemenata, CAMAR, desni	Kom.	400
PN01L	Poklopac nosača visećih elemenata, CAMAR, lijevi	Kom.	400

ŠIFRA ARTIKLA	OPIS ARTIKLA	J.M.	
NV041	Nosač visećih elemenata, sivi, L+D	Par.	100

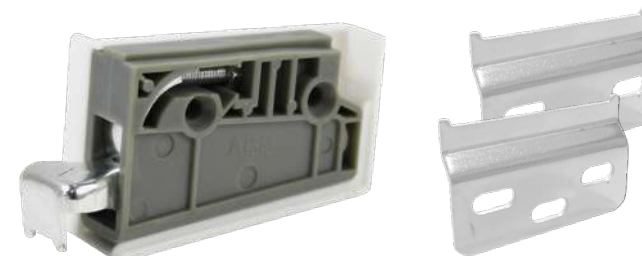

CAMAR® the art of innovation

ŠIFRA ARTIKLA	OPIS ARTIKLA	J.M.	
NVEF	Nosač visećeg elementa, FORCE, 1,5mm	Par.	80



ŠIFRA ARTIKLA	OPIS ARTIKLA	J.M.	
KPVC1	Kutnik PVC, 41.5x16mm	Kom.	100
KPVC1M	Kutnik PVC, 32.5x16mm	Kom.	250



ŠIFRA ARTIKLA	OPIS ARTIKLA	J.M.	
NVEL	Nosač visećeg elementa, "L", 1,2mm	Par.	100



ŠIFRA ARTIKLA	OPIS ARTIKLA	J.M.	
NVEE	Nosač visećeg elementa, EUROFLEX 1,2mm	Kom.	100

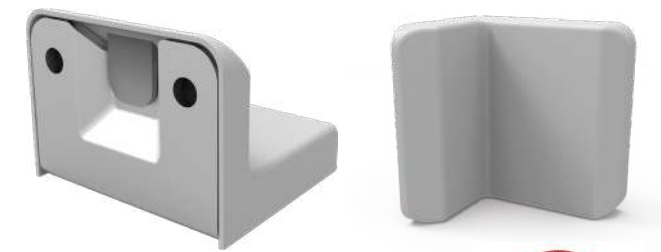

eurolflex
by kapsan



ŠIFRA ARTIKLA	OPIS ARTIKLA	J.M.	
DV001	Nosač, metalni, 40 x 15mm	Kom.	100



ŠIFRA ARTIKLA	OPIS ARTIKLA	J.M.	
NVEA	Nosač visećih elemenata	Kom.	100



ŠIFRA ARTIKLA	OPIS ARTIKLA	J.M.	
KPBI138	Kutnik s pokrivkom, bijeli, 17x28mm	Kom.	200



ŠIFRA ARTIKLA	OPIS ARTIKLA	J.M.	
KPBI4	Kutnik s pokrivkom, 4 pričvrstne rupe, bijeli, 32x22mm	Kom.	100



ŠIFRA ARTIKLA	OPIS ARTIKLA	J.M.	
KMB	Kutnik, mali, 100/1	Cet.	1



ŠIFRA ARTIKLA	OPIS ARTIKLA	J.M.	
KPVC2	Kutna spojnica	Kom.	100



ŠIFRA ARTIKLA	OPIS ARTIKLA	J.M.	
NPV5	Nosač police, Ø5mm, sa središnjim vijencem, 100/1	Cet.	50



ŠIFRA ARTIKLA	OPIS ARTIKLA	J.M.	
NPE	Nosač police, sa ekserom, 100/1	Cet.	10



ŠIFRA ARTIKLA	OPIS ARTIKLA	J.M.	
NSP5	Nosač staklene police, Ø 5mm, 100/1	Cet.	50



ŠIFRA ARTIKLA	OPIS ARTIKLA	J.M.	
NRR	Nosač rukohvata, inox, ravni	Kom.	100

NRO	Nosač rukohvata, inox, okrugli	Kom.	100
-----	--------------------------------	------	-----



DEKORATIVNI NOSAČI POLICA

ŠIFRA ARTIKLA	OPIS ARTIKLA	J.M.	
NP1B	Ukrasni nosač police, 110x155mm, bijeli	Kom.	20
NP2B	Ukrasni nosač police, 135x190mm, bijeli	Kom.	20
NP3B	Ukrasni nosač police, 155x230mm, bijeli	Kom.	20

ŠIFRA ARTIKLA	OPIS ARTIKLA	J.M.	
NP1S	Ukrasni nosač police, 110x155mm, bronzna	Kom.	20
NP2S	Ukrasni nosač police, 135x190mm, bronzna	Kom.	20
NP3S	Ukrasni nosač police, 155x230mm, bronzna	Kom.	20

ŠIFRA ARTIKLA	OPIS ARTIKLA	J.M.	
NP1C	Ukrasni nosač police, 110x155mm, crni	Kom.	20
NP2C	Ukrasni nosač police, 135x190mm, crni	Kom.	20
NP3C	Ukrasni nosač police, 155x230mm, crni	Kom.	20



SKRIVENE I SKLOPIVE KONZOLE

ŠIFRA ARTIKLA	OPIS ARTIKLA	J.M.	
SK30B	Sklopiva konzola 30cm, bijela	Par	10
SK30C	Sklopiva konzola 30cm, crna	Par	10
SK35B	Sklopiva konzola 35cm, bijela	Par	10
SK35C	Sklopiva konzola 35cm, crna	Par	10

ŠIFRA ARTIKLA	OPIS ARTIKLA	J.M.	
SK10100	Skrivena konzola, 10 x 100 mm.	Kom.	10
SK14140	Skrivena konzola, 14x140 mm.	Kom.	10
SK10145	Skrivena konzola, 10x145 mm.	Kom.	10



ŠIFRA ARTIKLA	OPIS ARTIKLA	J.M.	
ZK201	Zidna konzola LIGHT, bijela, 200mm	Kom.	24
ZK251	Zidna konzola LIGHT, bijela, 250mm	Kom.	24



Dvostruki sistem zidnih polica

Sistem zidnih polica se sastoji od zidnog nosača koji se pričvršćuje vijcima na zid, nosača police 'U' koji se klikne u zidni nosač i same police koja se postavi na nosač police. Ovakav sistem zidnih polica omogućava naknadno efikasno i lako premiještanje polica po visini.

Uz sisteme zidnih polica, Contego d.o.o. Vam nudi izradu i polica od visokokvalitetnih iverala i MDF ploča, uz ponudu od preko 200 različitih dekora.

ŠIFRA ARTIKLA	OPIS ARTIKLA	J.M.	
ZNU051	Zidni nosač LIGHT, bijeli, 500mm	Kom.	10
ZNU101	Zidni nosač LIGHT, bijeli, 1000mm	Kom.	10
ZNU201	Zidni nosač LIGHT, bijeli, 2000mm	Kom.	10



ŠIFRA ARTIKLA	OPIS ARTIKLA	J.M.	
ZK301	Zidna konzola STRONG, bijela, 300mm Kom.	24	
ZK401	Zidna konzola STRONG, bijela, 400mm Kom.	24	

ŠIFRA ARTIKLA	OPIS ARTIKLA	J.M.	
ZNŠ051	Zidni nosač STRONG, bijeli, 500mm Kom.	10	
ZNŠ101	Zidni nosač STRONG, bijeli, 1000mm Kom.	10	
ZNŠ201	Zidni nosač STRONG, bijeli, 2000mm Kom.	10	



Dvostruki sistem zidnih policia

Moguće kombinacije:
 Visina: 50, 100 i 200 cm
 Dubina: 20 - 40 cm
 Širina: 90 cm između 2 zidna nosača

Uz sisteme zidnih policia, Contego d.o.o. Vam nudi izradu i policia od visokokvalitetnih iverala i MDF ploča, uz ponudu od preko 200 različitih dekora.

Kombinacije sa drugim materijalima

Svi elementi sistema su izrađeni od kvalitetnog čelika zaštićenog plastifikacijom. Zidni nosači i nosači policie se mogu kombinirati sa policama od bilo kojeg drugog materijala: drvo, iveral, staklo, kompozitni materijali.



PLINSKI AMORTIZERI

ŠIFRA ARTIKLA	OPIS ARTIKLA	J.M.	
PA60W	Plinski amortizer sa ublaživačem, 60N, bijeli, AOSITE	Kom.	25
PA80W	Plinski amortizer sa ublaživačem, 80N, bijeli, AOSITE	Kom.	25
PA100W	Plinski amortizer sa ublaživačem, 100N, bijeli, AOSITE	Kom.	25

ŠIFRA ARTIKLA	OPIS ARTIKLA	J.M.	
PA60XA	Plinski amortizer, 60N, AOSITE, kontra otvaranje	Kom.	25
PA80XA	Plinski amortizer, 80N, AOSITE, kontra otvaranje	Kom.	25
PA100XA	Plinski amortizer, 100N, AOSITE, kontra otvaranje	Kom.	25



ŠIFRA ARTIKLA	OPIS ARTIKLA	J.M.	
PA60	Plinski amortizer, 60N	Kom.	25
PA80	Plinski amortizer, 80N	Kom.	25
PA100	Plinski amortizer, 100N	Kom.	25
PA120	Plinski amortizer, 120N	Kom.	25
PA80X	Plinski amortizer, 80N, kontra otvaranje	Kom.	25



conax

ŠIFRA ARTIKLA	OPIS ARTIKLA	J.M.	
PA60S	Plinski amortizer, 60N, sa ublaživačem	Kom.	25
PA80S	Plinski amortizer, 80N, sa ublaživačem	Kom.	25
PA100S	Plinski amortizer, 100N, sa ublaživačem	Kom.	25



conax

GAMET PLINSKI AMORTIZERI



ŠIFRA ARTIKLA	OPIS ARTIKLA	J.M.	
PA60G	Plinski amortizer 60N , GAMET	Kom.	100
PA80G	Plinski amortizer 80N , GAMET	Kom.	100
PA100G	Plinski amortizer 100N , GAMET	Kom.	100



ŠIFRA ARTIKLA	OPIS ARTIKLA	J.M.	
PA60GS	Plinski amortizer 60N , GAMET, sa ublaživačem	Kom.	100
PA80GS	Plinski amortizer 80N , GAMET, sa ublaživačem	Kom.	100
PA100GS	Plinski amortizer 100N , GAMET, sa ublaživačem	Kom.	100



ŠIFRA ARTIKLA	OPIS ARTIKLA	J.M.	
PA80XG	Plinski amortizer 80N, GAMET, kontra otvaranje	Kom.	100



ŠIFRA ARTIKLA	OPIS ARTIKLA	J.M.	
SM047	Škare metalne	Kom.	10



METALNI KUTNICI I SPOJNICE

ŠIFRA ARTIKLA	OPIS ARTIKLA	J.M.	
L162525	L kutnik, 16x25x25	Kom.	100
L163030	L kutnik, 16x30x30	Kom.	100
L152525	L kutnik, 15x25x25	Kom.	100
L153535	L kutnik, 15x35x35	Kom.	100
L154545	L kutnik, 15x45x45	Kom.	100
L155555	L kutnik, 15x55x55	Kom.	100



ŠIFRA ARTIKLA	OPIS ARTIKLA	J.M.	
L302525	L kutnik, 30x25x25	Kom.	100
L303535	L kutnik, 30x35x35	Kom.	100
L304545	L kutnik, 30x45x45	Kom.	100
L355050	L kutnik, 35x50x50	Kom.	100
L456060	L kutnik, 45x60x60	Kom.	100



ŠIFRA ARTIKLA	OPIS ARTIKLA	J.M.	
L203030	L kutnik, 20x30x30	Kom.	100
L204040	L kutnik, 20x40x40	Kom.	100
L205050	L kutnik, 20x50x50	Kom.	100



ŠIFRA ARTIKLA	OPIS ARTIKLA	J.M.	
I1660	Spojnica ravna, metalna, 16x60	Kom.	100
I1550	Spojnica ravna, metalna, 15x50	Kom.	100
I1570	Spojnica ravna, metalna, 15x70	Kom.	100
I1590	Spojnica ravna, metalna, 15x90	Kom.	100
I15110	Spojnica ravna, metalna, 15x110	Kom.	100



ŠIFRA ARTIKLA	OPIS ARTIKLA	J.M.	
PKZ300	Plastični "kvadratni" zavoj oko sifona, 300mm	Kom.	10
PUZ	Plastični "U" zavoj oko sifona	Kom.	10

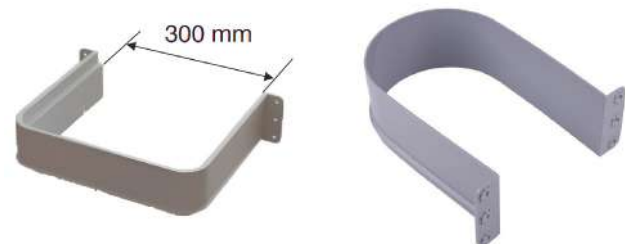

ŠIFRA ARTIKLA	OPIS ARTIKLA	J.M.	
KPS	Korekcijska pločica za spone	Kom.	100



ŠIFRA ARTIKLA	OPIS ARTIKLA	J.M.	
S-2281-GP	Umetak za ladice, 30cm, sivi	Kom.	15
S-2282-GP	Umetak za ladice, 35cm, sivi	Kom.	15
S-2283-GP	Umetak za ladice, 40cm, sivi	Kom.	15
S-2284-GP	Umetak za ladice, 45cm, sivi	Kom.	15
S-2285-GP	Umetak za ladice, 50cm, sivi	Kom.	15
S-2287-GP	Umetak za ladice, 60cm, sivi	Kom.	15
S-2289-GP	Umetak za ladice, 80cm, sivi	Kom.	15



STARAX
KITCHEN AND FURNITURE ACCESSORIES



ŠIFRA ARTIKLA	OPIS ARTIKLA	J.M.	
PUZE	Plastični "U" zavoj oko sifona, EUROFLEX	Kom.	10



eurolflex
by kapsan

ŠIFRA ARTIKLA	OPIS ARTIKLA	J.M.	
035W	PVC bijeli čep, za frontu, Ø 35mm	Kom.	100



ŠIFRA ARTIKLA	OPIS ARTIKLA	J.M.	
UL300	Umetak za ladice 300/340mm	Kom.	25
UL350	Umetak za ladice 350/390mm	Kom.	25
UI500	Umetak za ladice 500/540mm	Kom.	25



SPONE ZA NAMJEŠTAJ

AOSITE[®]

DVS
SOLUTIONS FOR FURNITURE

ŠIFRA ARTIKLA	OPIS ARTIKLA	J.M.	
---------------	--------------	------	---

SR35A Spona ravna, Ø35mm, sa podloškom Kom. 200



ŠIFRA ARTIKLA	OPIS ARTIKLA	J.M.	
---------------	--------------	------	---

SP35A Spona polukriva, Ø35mm, sa podloškom Kom. 200



ŠIFRA ARTIKLA	OPIS ARTIKLA	J.M.	
---------------	--------------	------	---

SK35A Spona kriva, Ø35mm, sa podloškom Kom. 200



ŠIFRA ARTIKLA	OPIS ARTIKLA	J.M.	
---------------	--------------	------	---

SRP35A Spona ravna, PUSH-TO-OPEN, Ø35mm, AOSITE Par. 100



PUSH-TO-OPEN



3D SPONA - AOSITE - CRNA

ŠIFRA ARTIKLA	OPIS ARTIKLA	J.M.	
---------------	--------------	------	---

SRU353DAC Spona ravna 3D, Ø35 ,sa podloškom i ublaživačem, 2/1, AOSITE, crna Par. 100



3D SPONE - AOSITE

ŠIFRA ARTIKLA	OPIS ARTIKLA	J.M.	
---------------	--------------	------	---

SRU353DA Spona ravna 3D, Ø35 ,sa podloškom i ublaživačem, 2/1, AOSITE Par. 100



ŠIFRA ARTIKLA	OPIS ARTIKLA	J.M.	
---------------	--------------	------	---

SPU353DA Spona polukriva 3D, Ø35 ,sa podloškom i ublaživačem, 2/1, AOSITE Par. 100



ŠIFRA ARTIKLA	OPIS ARTIKLA	J.M.	
---------------	--------------	------	---

SKU353DA Spona kriva 3D, Ø35 ,sa podloškom i ublaživačem, 2/1, AOSITE Par. 100



2D SPONE - AOSITE

ŠIFRA ARTIKLA	OPIS ARTIKLA	J.M.	
---------------	--------------	------	---

SRU352DA Spona ravna 2D, Ø35 ,sa podloškom i ublaživačem, 2/1, AOSITE Par. 100



ŠIFRA ARTIKLA	OPIS ARTIKLA	J.M.	
---------------	--------------	------	---

SPU352DA Spona polukriva 2D, Ø35 ,sa podloškom i ublaživačem, 2/1, AOSITE Par. 100



ŠIFRA ARTIKLA	OPIS ARTIKLA	J.M.	
---------------	--------------	------	---

SKU352DA Spona kriva 2D, Ø35 ,sa podloškom i ublaživačem, 2/1, AOSITE Par. 100



ŠIFRA ARTIKLA	OPIS ARTIKLA	J.M.	
---------------	--------------	------	---

S3530 Spona, Ø35mm, sa podloškom, 30° Kom. 100



ŠIFRA ARTIKLA	OPIS ARTIKLA	J.M.	
---------------	--------------	------	---

S35115 Spona, Ø35mm, sa podloškom, 115° Kom. 100



ŠIFRA ARTIKLA	OPIS ARTIKLA	J.M.	
---------------	--------------	------	---

S35180 Spona, Ø35mm, sa podloškom, 180° Kom. 100



ŠIFRA ARTIKLA	OPIS ARTIKLA	J.M.	
---------------	--------------	------	---

SRU35S Spona ravna, Ø35mm, za staklena vrata, sa ublaživačem Par. 100

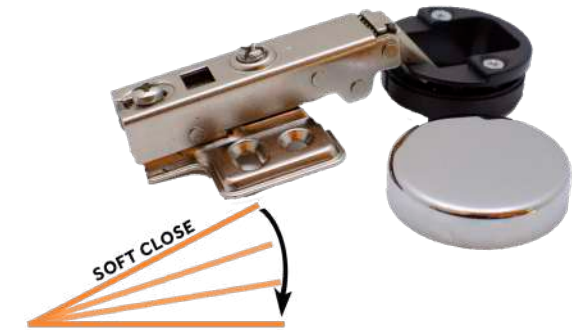

ŠIFRA ARTIKLA	OPIS ARTIKLA	J.M.	
---------------	--------------	------	---

S3545 Spona, Ø35mm, sa podloškom, 45° Kom. 100



ŠIFRA ARTIKLA	OPIS ARTIKLA	J.M.	
---------------	--------------	------	---

S35135 Spona, Ø35mm, sa podloškom, 135° Kom. 100



AOSITE SPONE SA UBLAŽIVAČEM

ŠIFRA ARTIKLA	OPIS ARTIKLA	J.M.	
---------------	--------------	------	---

SU30A Spona, Ø35mm, sa podloškom i ublaživačem, 30°, AOSITE Kom. 100

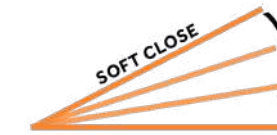

ŠIFRA ARTIKLA	OPIS ARTIKLA	J.M.	
---------------	--------------	------	---

SU90A Spona, Ø35mm, sa podloškom i ublaživačem, 90°, AOSITE Kom. 100



ŠIFRA ARTIKLA	OPIS ARTIKLA	J.M.	
---------------	--------------	------	---

S3590 Spona, Ø35mm, sa podloškom, 90° Kom. 100



ŠIFRA ARTIKLA	OPIS ARTIKLA	J.M.	
---------------	--------------	------	---

S35165 Spona, Ø35mm, sa podloškom, 165° Kom. 100



ŠIFRA ARTIKLA	OPIS ARTIKLA	J.M.	
---------------	--------------	------	---

SU45A Spona, Ø35mm, sa podloškom i ublaživačem, 45°, AOSITE Kom. 100



ŠIFRA ARTIKLA	OPIS ARTIKLA	J.M.	
---------------	--------------	------	---

SU165A Spona, Ø35mm, sa podloškom i ublaživačem, 165°, AOSITE Kom. 100



TIP-ON UBLAŽIVAČI ZA SPONE

ŠIFRA ARTIKLA	OPIS ARTIKLA	J.M.	
TOS094	TIP ON, PVC, 094	Kom.	50



ŠIFRA ARTIKLA	OPIS ARTIKLA	J.M.	
TOS192	Tip ON, sivi	Kom.	50



ŠIFRA ARTIKLA	OPIS ARTIKLA	J.M.	
TOI093	TIP ON, Stainless steel, INOX	Kom.	50



ŠIFRA ARTIKLA	OPIS ARTIKLA	J.M.	
TO195	TIP-ON, mod.195, PVC	Kom.	50



ŠIFRA ARTIKLA	OPIS ARTIKLA	J.M.	
TO2100	TIP-ON, 2100, AOSITE, zlatni	Kom.	50



ŠIFRA ARTIKLA	OPIS ARTIKLA	J.M.	
TO2300	TIP-ON, 2300, AOSITE, PVC	Kom.	50



ŠIFRA ARTIKLA	OPIS ARTIKLA	J.M.	
TO2900	TIP-ON, 2900, AOSITE, INOX	Kom.	50



VJEŠALICE I RUČKE ZA NAMJEŠTAJ

ŠIFRA ARTIKLA	OPIS ARTIKLA	J.M.	
RI14196	Ručka, "RELING", 96mm	Kom.	25
RI141128	Ručka, "RELING", 128mm	Kom.	25
RI141160	Ručka, "RELING", 160mm	Kom.	25
RI141192	Ručka, "RELING", 192mm	Kom.	25
RI141224	Ručka, "RELING", 224mm	Kom.	25
RI141256	Ručka, "RELING", 256mm	Kom.	25
RI141288	Ručka, "RELING", 288mm	Kom.	25
RI141320	Ručka, "RELING", 320mm	Kom.	25
RI141352	Ručka, "RELING", 352mm	Kom.	25
RI141512	Ručka, "RELING", 512mm	Kom.	25



ŠIFRA ARTIKLA	OPIS ARTIKLA	J.M.	
R14296	Ručka, "RELING", 96mm, ECO	Kom.	50
R142128	Ručka, "RELING", 128mm, ECO	Kom.	50
R142160	Ručka, "RELING", 160mm, ECO	Kom.	50

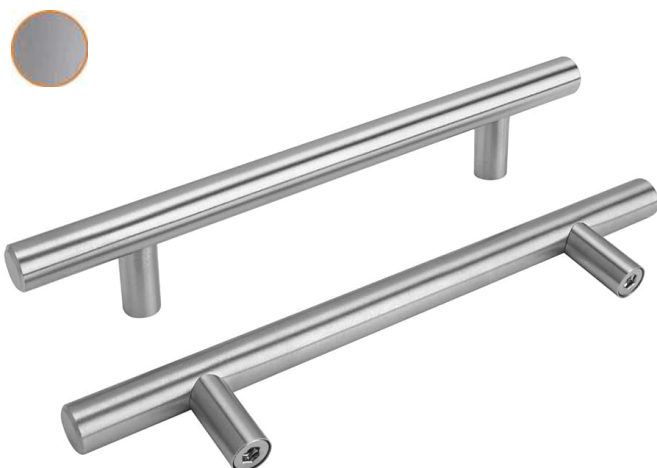

ŠIFRA ARTIKLA	OPIS ARTIKLA	J.M.	
RC14196	Ručka, "RELING", 96mm, crna	Kom.	20
RC141128	Ručka, "RELING", 128mm, crna	Kom.	20
RC141160	Ručka, "RELING", 160mm, crna	Kom.	20
RC141192	Ručka, "RELING", 192mm, crna	Kom.	20

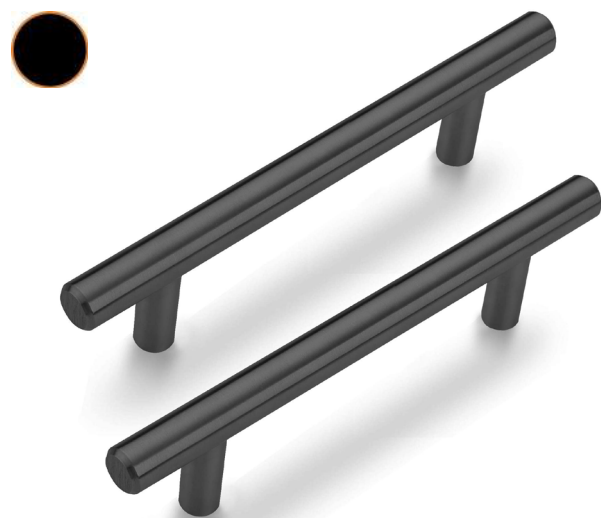

ŠIFRA ARTIKLA	OPIS ARTIKLA	J.M.	
RC14296	Ručka RELING, 96mm, crni-ECO	Kom.	50
RC142128	Ručka RELING, 128mm, crni-ECO	Kom.	50
RC142160	Ručka RELING, 160mm, crni-ECO	Kom.	50
RC142192	Ručka RELING, 192mm, crni-ECO	Kom.	50



ŠIFRA ARTIKLA	OPIS ARTIKLA	J.M.	
RKM18696	Ručka, krom-mat, mod.186, 96mm, usadna	Kom.	50
RKM186128	Ručka, krom-mat, mod.186, 128mm, usadna	Kom.	50
RKM186160	Ručka, krom-mat, mod.186, 160mm, usadna	Kom.	50



ŠIFRA ARTIKLA	OPIS ARTIKLA	J.M.	
RU35	Ručka, usadna, fi35	Kom.	100



ŠIFRA ARTIKLA	OPIS ARTIKLA	J.M.	
RC452128	Ručka, mod.452, crna, 128mm	Kom.	50
RC452160	Ručka, mod.452, crna, 160mm	Kom.	50



ŠIFRA ARTIKLA	OPIS ARTIKLA	J.M.	
RJS155	Ručka, mod.155, saten, jednovijčana	Kom.	80
RJC155	Ručka, mod.155, crna, jednovijčana	Kom.	80



ŠIFRA ARTIKLA	OPIS ARTIKLA	J.M.	
RJS155	Ručka, mod.155, saten, jednovijčana	Kom.	80
RJC155	Ručka, mod.155, crna, jednovijčana	Kom.	80



ŠIFRA ARTIKLA	OPIS ARTIKLA	J.M.	
RS14296	Ručka, mod.142, saten, 96mm	Kom.	50
RS142128	Ručka, mod.142, saten, 128mm	Kom.	50
RS142160	Ručka, mod.142, saten, 160mm	Kom.	50



ŠIFRA ARTIKLA	OPIS ARTIKLA	J.M.	
RC14396	Ručka, mod.143, crna, 96mm	Kom.	50
RC143182	Ručka, mod.143, crna, 128mm	Kom.	50
RC143160	Ručka, mod.143, crna, 160mm	Kom.	50
RC143192	Ručka, mod.143, crna, 192mm	Kom.	50
RC143224	Ručka, mod.143, crna, 224mm	Kom.	50



ŠIFRA ARTIKLA	OPIS ARTIKLA	J.M.	
RS14396	Ručka, mod.143, mat siva, 96mm	Kom.	50
RS143182	Ručka, mod.143, mat siva, 128mm	Kom.	50
RS143160	Ručka, mod.143, mat siva, 160mm	Kom.	50
RS143192	Ručka, mod.143, mat siva, 192mm	Kom.	50
RS143224	Ručka, mod.143, mat siva, 224mm	Kom.	50



ŠIFRA ARTIKLA	OPIS ARTIKLA	J.M.	
RS406128	Ručka, mod.406, saten, 128mm	Kom.	50
RS406192	Ručka, mod.406, saten, 192mm	Kom.	50



ŠIFRA ARTIKLA	OPIS ARTIKLA	J.M.	
RC304128	Ručka, mod.304, crna sa kromiranim ivicama, 128mm	Kom.	50
RC304160	Ručka, mod.304, crna sa kromiranim ivicama, 160mm	Kom.	50
RC304192	Ručka, mod.304, crna sa kromiranim ivicama, 192mm	Kom.	50



ŠIFRA ARTIKLA	OPIS ARTIKLA	J.M.	
RS304128	Ručka, mod.304, stainless steel, 128mm	Kom.	50
RS304160	Ručka, mod.304, stainless steel, 160mm	Kom.	50
RS304192	Ručka, mod.304, stainless steel, 192mm	Kom.	50



ŠIFRA ARTIKLA	OPIS ARTIKLA	J.M.	
RC1600	Ručka, mod.1, 600mm, crna	Kom.	10
RMS1600	Ručka, mod.1, 600mm, mat siva	Kom.	10
RC11000	Ručka, mod.1, 1000mm, crna	Kom.	10
RMS11000	Ručka, mod.1, 1000mm, mat siva	Kom.	10



ŠIFRA ARTIKLA	OPIS ARTIKLA	J.M.	
RC2600	Ručka, mod.2, 600mm, crna	Kom.	10
RTS2600	Ručka, mod.2, 600mm, tamni saten	Kom.	10
RC21000	Ručka, mod.2, 1000mm, crna	Kom.	10
RTS21000	Ručka, mod.2, 1000mm, tamni saten	Kom.	10



ŠIFRA ARTIKLA	OPIS ARTIKLA	J.M.	
RS130128	Ručka, mod.130, 128mm, saten	Kom.	50
RS130160	Ručka, mod.130, 160mm, saten	Kom.	50
RS130192	Ručka, mod.130, 192mm, saten	Kom.	50



ŠIFRA ARTIKLA	OPIS ARTIKLA	J.M.	
RC130128	Ručka, mod.130, 128mm, crna	Kom.	50
RC130160	Ručka, mod.130, 160mm, crna	Kom.	50
RC130192	Ručka, mod.130, 192mm, crna	Kom.	50



ŠIFRA ARTIKLA	OPIS ARTIKLA	J.M.	
VMS174	Vješalica , mod.174 , saten , mala	Kom.	50
VVS174	Vješalica , mod.174 , saten , velika	Kom.	50
VMC174	Vješalica , mod.174 , crna , mala	Kom.	50
VVC174	Vješalica , mod.174 , crna , velika	Kom.	50



ŠIFRA ARTIKLA	OPIS ARTIKLA	J.M.	
VKSM194	Vješalica , mod.194 , krom-saten , mala	Kom.	50
VKSV194	Vješalica , mod.194 , krom-saten , velika	Kom.	50



ŠIFRA ARTIKLA	OPIS ARTIKLA	J.M.	
VSM193	Vješalica , mod.193 , saten , mala	Kom.	50
VSV193	Vješalica , mod.193 , saten , velika	Kom.	50
VCV193	Vješalica , mod. 193 , crna , velika	Kom.	50
VCM193	Vješalica , mod.193 , crna , mala	Kom.	50



ŠIFRA ARTIKLA	OPIS ARTIKLA	J.M.	
VMS175	Vješalica , mod.175 , saten , mala	Kom.	50
VVS175	Vješalica , mod. 175 , saten , velika	Kom.	50



ŠIFRA ARTIKLA	OPIS ARTIKLA	J.M.	
VC64	Vješalica , mod.64 , crna	Kom.	50



ŠIFRA ARTIKLA	OPIS ARTIKLA	J.M.	
VC65	Vješalica , mod.65 , crna	Kom.	50



ŠIFRA ARTIKLA	OPIS ARTIKLA	J.M.	
VC80	Vješalica , mod.80 , crna	Kom.	50



viva[®] HANDLE

VJEŠALICE I RUČKE ZA NAMJEŠTAJ

ŠIFRA ARTIKLA	OPIS ARTIKLA	J.M.	
RI442160	Ručka, 442, inox, 160mm	Kom.	50
RI442192	Ručka, 442, inox, 192mm	Kom.	50
RC442160	Ručka, 442, crna, 160mm	Kom.	50
RC442192	Ručka, 442, crna, 192mm	Kom.	50

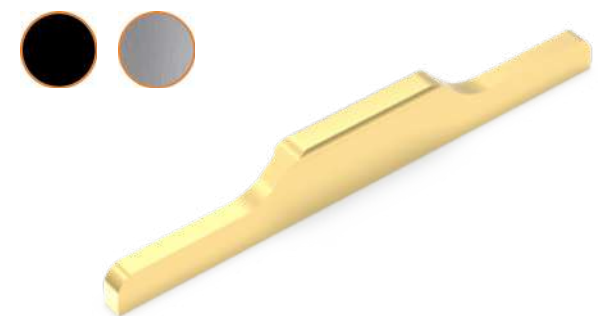

ŠIFRA ARTIKLA	OPIS ARTIKLA	J.M.	
RK253160	Ručka, 253, krom, 160mm	Kom.	50
RK253192	Ručka, 253, krom, 192mm	Kom.	50
RK253224	Ručka, 253, krom, 224mm	Kom.	50
RC253160	Ručka, 253, crna, 160mm	Kom.	50
RC253192	Ručka, 253, crna, 192mm	Kom.	50
RC253224	Ručka, 253, crna, 224mm	Kom.	50



ŠIFRA ARTIKLA	OPIS ARTIKLA	J.M.	
RK388128	Ručka, 388, krom, 128mm	Kom.	50
RK388160	Ručka, 388, krom, 160mm	Kom.	50
RK388192	Ručka, 388, krom, 192mm	Kom.	50
RA388128	Ručka, 388, antracit, 128mm	Kom.	50
RA388160	Ručka, 388, antracit, 160mm	Kom.	50
RA388192	Ručka, 388, antracit, 192mm	Kom.	50
RG388128	Ručka, 388, gold, 128mm	Kom.	50
RG388129	Ručka, 388, gold, 160mm	Kom.	50
RG388130	Ručka, 388, gold, 192mm	Kom.	50



ŠIFRA ARTIKLA	OPIS ARTIKLA	J.M.	
RC389128	Ručka, 389, crna, 128mm	Kom.	50
RC389160	Ručka, 389, crna, 160mm	Kom.	50
RC389192	Ručka, 389, crna, 192mm	Kom.	50
RC389224	Ručka, 389, crna, 224mm	Kom.	50



ŠIFRA ARTIKLA	OPIS ARTIKLA	J.M.	
RI806128	Ručka, 806, inox, 128mm	Kom.	50
RI806160	Ručka, 806, inox, 160mm	Kom.	50
RI806192	Ručka, 806, inox, 192mm	Kom.	50



ŠIFRA ARTIKLA	OPIS ARTIKLA	J.M.	
RC841192	Ručka, 841, crna, 192mm	Kom.	50
RC841224	Ručka, 841, crna, 224mm	Kom.	50
RB841192	Ručka, 841, bijela, 192mm	Kom.	50
RB841224	Ručka, 841, bijela, 224mm	Kom.	50



ŠIFRA ARTIKLA	OPIS ARTIKLA	J.M.	
RA327160	Ručka, 327, antracit, 160mm	Kom.	50
RA327224	Ručka, 327, antracit, 224mm	Kom.	50



ŠIFRA ARTIKLA	OPIS ARTIKLA	J.M.	
RC80796	Ručka, 807, crna, 96mm	Kom.	50
RC807128	Ručka, 807, crna, 128mm	Kom.	50
RC807160	Ručka, 807, crna, 160mm	Kom.	50
RC807192	Ručka, 807, crna, 192mm	Kom.	50
RB80796	Ručka, 807, bijela, 96mm	Kom.	50
RB807128	Ručka, 807, bijela, 128mm	Kom.	50
RB807160	Ručka, 807, bijela, 160mm	Kom.	50
RB807192	Ručka, 807, bijela, 192mm	Kom.	50
RMG80796	Ručka, 807, mat gold, 96mm	Kom.	50
RMG807128	Ručka, 807, mat gold, 128mm	Kom.	50
RMG807160	Ručka, 807, mat gold, 160mm	Kom.	50
RMG807192	Ručka, 807, mat gold, 192mm	Kom.	50
RMK80796	Ručka, 807, mat-krom, 96mm	Kom.	50
RMK807128	Ručka, 807, mat-krom, 128mm	Kom.	50
RMK807160	Ručka, 807, mat-krom, 160mm	Kom.	50
RMK807192	Ručka, 807, mat-krom, 192mm	Kom.	50



ŠIFRA ARTIKLA	OPIS ARTIKLA	J.M.	
RK313128	Ručka, 313, krom, 128mm	Kom.	50
RK313160	Ručka, 313, krom, 160mm	Kom.	50



ŠIFRA ARTIKLA	OPIS ARTIKLA	J.M.	
RI255600	Ručka 255, inox(V2), 600mm	Kom.	10
RI255900	Ručka 255, inox(V2), 900mm	Kom.	10
RC255600	Ručka 255, crna(V5), 600mm	Kom.	10
RC255900	Ručka 255, crna(V5), 900mm	Kom.	10



ŠIFRA ARTIKLA	OPIS ARTIKLA	J.M.	
RK306128	Ručka , 306 , krom , 128mm	Kom.	50
RK306160	Ručka , 306 , krom , 160mm	Kom.	50
RK306224	Ručka , 306 , krom , 224mm	Kom.	50
RC306128	Ručka , 306 , crna , 128mm	Kom.	50
RC306160	Ručka , 306 , crna , 160mm	Kom.	50
RC306224	Ručka , 306 , crna , 224mm	Kom.	50



ŠIFRA ARTIKLA	OPIS ARTIKLA	J.M.	
RI315128	Ručka , 315 , inox , 128mm	Kom.	50
RI315160	Ručka , 315 , inox , 160mm	Kom.	50
RI315192	Ručka , 315 , inox , 192mm	Kom.	50



ŠIFRA ARTIKLA	OPIS ARTIKLA	J.M.	
RI303128	Ručka , 303 , inox , 128mm	Kom.	50
RI303160	Ručka , 303 , inox , 160mm	Kom.	50
RI303224	Ručka , 303 , inox , 224mm	Kom.	50
RI303320	Ručka , 303 , inox , 320mm	Kom.	50



ŠIFRA ARTIKLA	OPIS ARTIKLA	J.M.	
RK321128	Ručka , 321 , krom , 128mm	Kom.	50
RK321160	Ručka , 321 , krom , 160mm	Kom.	50
RK321192	Ručka , 321 , krom , 192mm	Kom.	50
RMK321128	Ručka , 321 , mat-krom , 128mm	Kom.	50
RMK321160	Ručka , 321 , mat-krom , 160mm	Kom.	50
RMK321192	Ručka , 321 , mat-krom , 192mm	Kom.	50



ŠIFRA ARTIKLA	OPIS ARTIKLA	J.M.	
RI302128	Ručka , 302 , inox , 128mm	Kom.	50
RI302160	Ručka , 302 , inox , 160mm	Kom.	50
RI302224	Ručka , 302 , inox , 224mm	Kom.	50



ŠIFRA ARTIKLA	OPIS ARTIKLA	J.M.	
RI324128	Ručka , 324 , inox , 128mm	Kom.	50
RI324160	Ručka , 324 , inox , 160mm	Kom.	50
RI324224	Ručka , 324 , inox , 224mm	Kom.	50
RC324128	Ručka , 324 , crna , 128mm	Kom.	50
RC324160	Ručka , 324 , crna , 160mm	Kom.	50
RC324224	Ručka , 324 , crna , 224mm	Kom.	50



ŠIFRA ARTIKLA	OPIS ARTIKLA	J.M.	
RI301160	Ručka , 301 , inox , 160mm	Kom.	50
RI301224	Ručka , 301 , inox , 224mm	Kom.	50
RI301320	Ručka , 301 , inox , 320mm	Kom.	50



ŠIFRA ARTIKLA	OPIS ARTIKLA	J.M.	
RA355128	Ručka , 355 , antracit , 128mm	Kom.	50
RA355160	Ručka , 355 , antracit , 160mm	Kom.	50
RA355192	Ručka , 355 , antracit , 192mm	Kom.	50



ŠIFRA ARTIKLA	OPIS ARTIKLA	J.M.	
RI314128	Ručka , 314 , inox , 128mm	Kom.	50
RI314160	Ručka , 314 , inox , 160mm	Kom.	50
RI314192	Ručka , 314 , inox , 192mm	Kom.	50
RI314224	Ručka , 314 , inox , 224mm	Kom.	50
RMK314128	Ručka , 314 , mat-krom , 128mm	Kom.	50
RMK314160	Ručka , 314 , mat-krom , 160mm	Kom.	50
RMK314192	Ručka , 314 , mat-krom , 192mm	Kom.	50
RMK314224	Ručka , 314 , mat-krom , 224mm	Kom.	50



ŠIFRA ARTIKLA	OPIS ARTIKLA	J.M.	
RK311128	Ručka , 311 , krom , 128mm	Kom.	50
RK311160	Ručka , 311 , krom , 160mm	Kom.	50
RK311192	Ručka , 311 , krom , 192mm	Kom.	50
RK311224	Ručka , 311 , krom , 224mm	Kom.	50



ŠIFRA ARTIKLA	OPIS ARTIKLA	J.M.	
REC96	Ručka "ETNA" , 883 , crna , 96mm	Kom.	50





ŠIFRA ARTIKLA	OPIS ARTIKLA	J.M.	
RI317128	Ručka , 317 , inox , 128mm	Kom.	50
RI317160	Ručka , 317 , inox , 160mm	Kom.	50
RI317224	Ručka , 317 , inox , 224mm	Kom.	50
RI317320	Ručka , 317 , inox , 320mm	Kom.	50



ŠIFRA ARTIKLA	OPIS ARTIKLA	J.M.	
RAY729160	Ručka , 729 , antique yellow , 160mm	Kom.	50



ŠIFRA ARTIKLA	OPIS ARTIKLA	J.M.	
RI305128	Ručka , 305 , inox , 128mm	Kom.	50
RI305160	Ručka , 305 , inox , 160mm	Kom.	50
RI305192	Ručka , 305 , inox , 192mm	Kom.	50
RI305224	Ručka , 305 , inox , 224mm	Kom.	50



ŠIFRA ARTIKLA	OPIS ARTIKLA	J.M.	
RC734160	Ručka , 734 , crna , 160mm	Kom.	50



ŠIFRA ARTIKLA	OPIS ARTIKLA	J.M.	
RB26550	Ručka , 265 , bijela , 50mm	Kom.	50
RB265100	Ručka , 265 , bijela , 100mm	Kom.	50
RB265150	Ručka , 265 , bijela , 150mm	Kom.	50
RB265200	Ručka , 265 , bijela 200mm	Kom.	50
RB265250	Ručka , 265 , bijela , 250mm	Kom.	50
RB265300	Ručka , 265 , bijela , 300mm	Kom.	50
RB265350	Ručka , 265 , bijela , 350mm	Kom.	50
RB265400	Ručka , 265 , bijela , 400mm	Kom.	50
RB265450	Ručka , 265 , bijela , 450mm	Kom.	50
RB265500	Ručka , 265 , bijela , 500mm	Kom.	50



ŠIFRA ARTIKLA	OPIS ARTIKLA	J.M.	
RC26550	Ručka , 265 , crna , 50mm	Kom.	50
RC265100	Ručka , 265 , crna , 100mm	Kom.	50
RC265150	Ručka , 265 , crna , 150mm	Kom.	50
RC265200	Ručka , 265 , crna 200mm	Kom.	50
RC265250	Ručka , 265 , crna , 250mm	Kom.	50
RC265300	Ručka , 265 , crna , 300mm	Kom.	50
RC265350	Ručka , 265 , crna , 350mm	Kom.	50
RC265400	Ručka , 265 , crna , 400mm	Kom.	50
RC265450	Ručka , 265 , crna , 450mm	Kom.	50
RC265500	Ručka , 265 , crna , 500mm	Kom.	50



ŠIFRA ARTIKLA	OPIS ARTIKLA	J.M.	
RJK537	Ručka jednovijčana , 537 , krom	Kom.	50
RJC537	Ručka jednovijčana , 537 , crna	Kom.	50



ŠIFRA ARTIKLA	OPIS ARTIKLA	J.M.	
RJC552	Ručka , jednovijčana , 552 , crna(V5)	Kom.	50
RJK552	Ručka , jednovijčana , 552 , krom(V1)	Kom.	50
RJG552	Ručka , jednovijčana , 552 , mat zlatna(V32)	Kom.	50



ŠIFRA ARTIKLA	OPIS ARTIKLA	J.M.	
RJK537	Ručka jednovijčana , 537 , krom	Kom.	50
RJC537	Ručka jednovijčana , 537 , crna	Kom.	50



ŠIFRA ARTIKLA	OPIS ARTIKLA	J.M.	
RJC552	Ručka , jednovijčana , 552 , crna(V5)	Kom.	50
RJK552	Ručka , jednovijčana , 552 , krom(V1)	Kom.	50
RJG552	Ručka , jednovijčana , 552 , mat zlatna(V32)	Kom.	50



ŠIFRA ARTIKLA	OPIS ARTIKLA	J.M.	
RJAC509	Ručka jednovijčana , 509 , antique copper	Kom.	50
RJC509	Ručka jednovijčana , 509 , black	Kom.	50
RJB509	Ručka jednovijčana , 509 , white	Kom.	50



ŠIFRA ARTIKLA	OPIS ARTIKLA	J.M.	
RJC542	Ručka jednovijčana , 542 , crna	Kom.	50
RJB542	Ručka jednovijčana , 542 , bijela	Kom.	50



ŠIFRA ARTIKLA	OPIS ARTIKLA	J.M.	
RJC571	Ručka , jednovijčana , 571 , crna(V5)	Kom.	50
RJB571	Ručka , jednovijčana , 571 , bijela(V6)	Kom.	50



ŠIFRA ARTIKLA	OPIS ARTIKLA	J.M.	
RJC411	Ručka , jednovijčana , 411 , crna(V5)	Kom.	50



ŠIFRA ARTIKLA	OPIS ARTIKLA	J.M.	
VK125	Vješalica, model 125, krom	Kom.	50
VC125	Vješalica, model 125, crna	Kom.	50
VA125	Vješalica, model 125, antracit	Kom.	50
VZ125	Vješalica, model 125, zlatna	Kom.	50



ŠIFRA ARTIKLA	OPIS ARTIKLA	J.M.	
VK126	Vješalica, model 126, krom	Kom.	50
VC126	Vješalica, model 126, crna	Kom.	50
VA126	Vješalica, model 126, antracit	Kom.	50
VZ126	Vješalica, model 126, zlatna	Kom.	50



ŠIFRA ARTIKLA	OPIS ARTIKLA	J.M.	
V1104	Vješalica , 104 , inox	Kom.	50
VC104	Vješalica , 104 , crna	Kom.	50
VB104	Vješalica , 104 , bijela	Kom.	50



ŠIFRA ARTIKLA	OPIS ARTIKLA	J.M.	
VC123	Vješalica, model 123, crna	Kom.	50
VA123	Vješalica, model 123, antracit	Kom.	50
VC124	Vješalica, model 124, crna	Kom.	50
VA124	Vješalica, model 124, antracit	Kom.	50



ALUMINIJSKI PROFILI ZA NAMJEŠTAJ

- PREMIUM KVALITET
- ZAŠTITNA FOLIJA NA SVIM PROFILIMA
- DOSTUPNOST PROFILA U 3 BOJE (ELOXAL, BIJELA I CRNA)



ŠIFRA ARTIKLA	OPIS ARTIKLA	J.M.	BOJA
---------------	--------------	------	------

5039 Rukohvat "BETA" / L-2,6m Kom. Eloxal

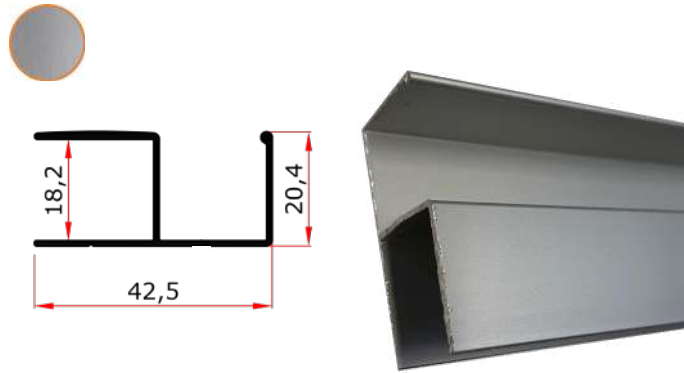

ŠIFRA ARTIKLA	OPIS ARTIKLA	J.M.	BOJA
---------------	--------------	------	------

5036 Rukohvat "BETA" / L-2,6m, sa uvlačnom četkicom Kom. Eloxal

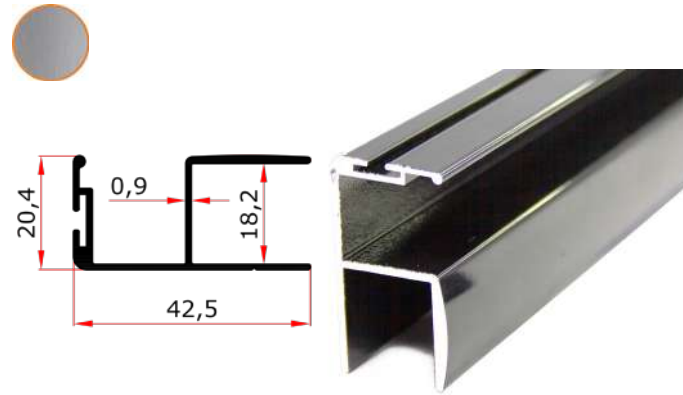

ŠIFRA ARTIKLA	OPIS ARTIKLA	J.M.	BOJA
---------------	--------------	------	------

5134 Rukohvat "GAMA-LUX" / L-2,6 m, sa uvlačnom četkicom Kom. Eloxal

5134BM Rukohvat "GAMA-LUX" / L-2,6 m, sa uvlačnom četkicom Kom. Crna mat

5134W Rukohvat "GAMA-LUX" / L-2,6 m, sa uvlačnom četkicom Kom. Bijela

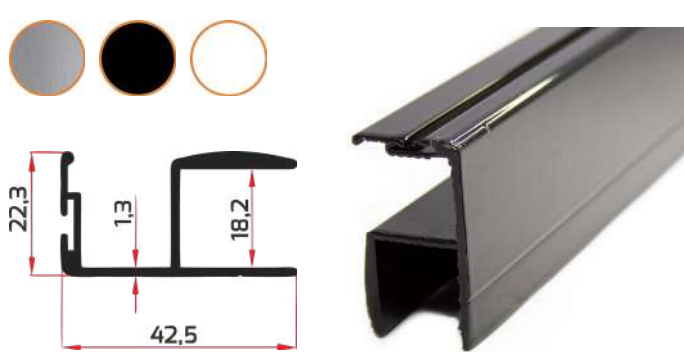

ŠIFRA ARTIKLA	OPIS ARTIKLA	J.M.	BOJA
---------------	--------------	------	------

5041 Rukohvat, ALFA / L-2,6m, sa uvlačnom četkicom Kom. Eloxal

5041W Rukohvat, ALFA / L-2,6m, sa uvlačnom četkicom Kom. Bijela



ŠIFRA ARTIKLA	OPIS ARTIKLA	J.M.	BOJA
---------------	--------------	------	------

5032 Gornja vodilica / L-6m m. Eloxal

5032BM Gornja vodilica / L-6m m. Crna mat

5032W Gornja vodilica / L-6m m. Bijela

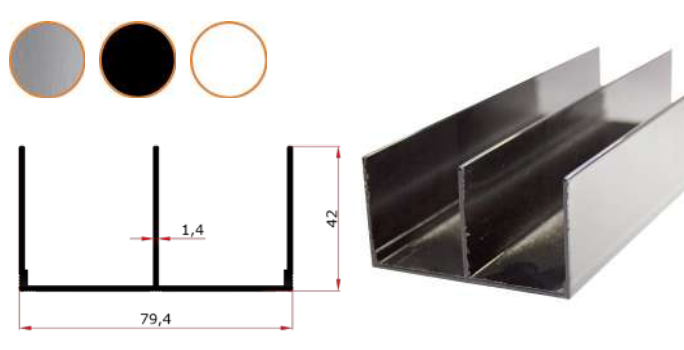

ŠIFRA ARTIKLA	OPIS ARTIKLA	J.M.	BOJA
---------------	--------------	------	------

5040 Donja vodilica / L-6m m. Eloxal

5040BM Donja vodilica / L-6m m. Crna mat

5040W Donja vodilica / L-6m m. Bijela

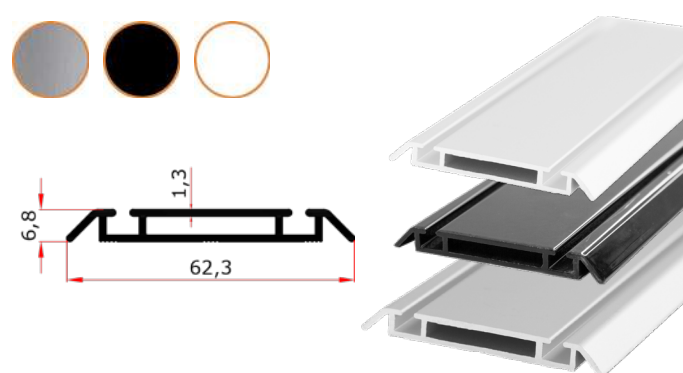

ŠIFRA ARTIKLA	OPIS ARTIKLA	J.M.	BOJA
---------------	--------------	------	------

6350 Gornja vodilica, EKO, L-6m m. Eloxal

6350BM Gornja vodilica, EKO, L-6m m. Crna mat

6350W Gornja vodilica, EKO, L-6m m. Bijela

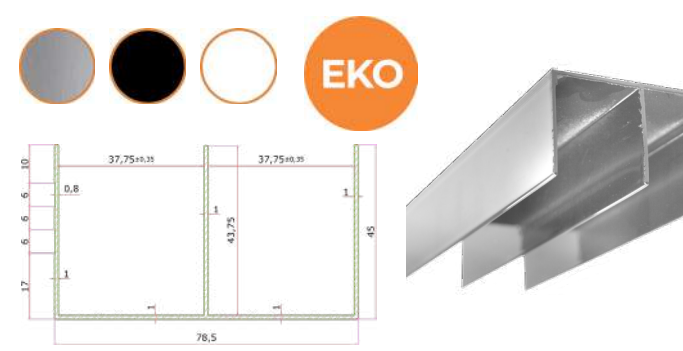

ŠIFRA ARTIKLA	OPIS ARTIKLA	J.M.	BOJA
---------------	--------------	------	------

6351 Donja vodilica, EKO, L-6m m. Eloxal

6351BM Donja vodilica, EKO, L-6m m. Crna mat

6351W Donja vodilica, EKO, L-6m m. Bijela



ŠIFRA ARTIKLA	OPIS ARTIKLA	J.M.	BOJA
---------------	--------------	------	------

5034 Profil H, L-3m Kom. Eloxal

5034BM Profil H, L-3m Kom. Crna mat

5034W Profil H, L-3m Kom. Bijela

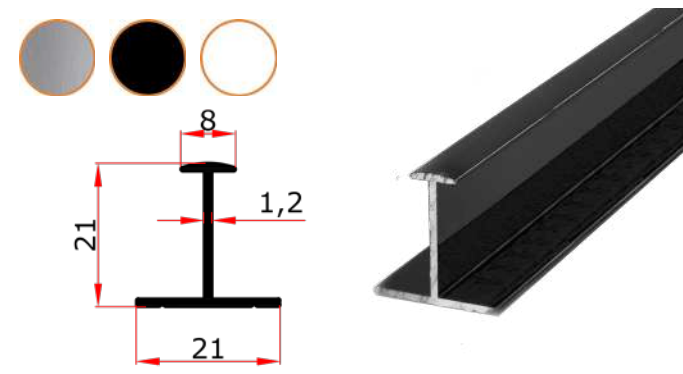

ŠIFRA ARTIKLA	OPIS ARTIKLA	J.M.	BOJA
---------------	--------------	------	------

5035 Profil "U", /L- 3m Kom. Eloxal

5035BM Profil "U", /L- 3m Kom. Crna mat

5035W Profil "U", /L- 3m Kom. Bijela

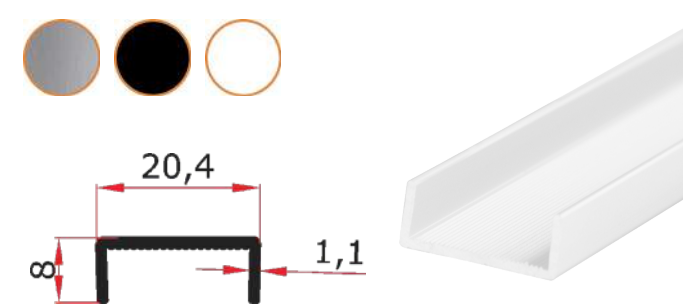

ŠIFRA ARTIKLA	OPIS ARTIKLA	J.M.	BOJA
---------------	--------------	------	------

5864 Profil "L", L-3m Kom. Eloxal

5864BM Profil "L", L-3m Kom. Crna mat

5864W Profil "L", L-3m Kom. Bijela

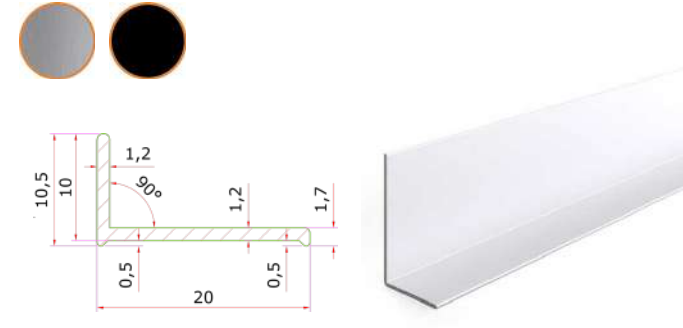

ŠIFRA ARTIKLA	OPIS ARTIKLA	J.M.	BOJA
---------------	--------------	------	------

OK110 Opruga-kočnica, za donju vodilicu Kom. Aluminium

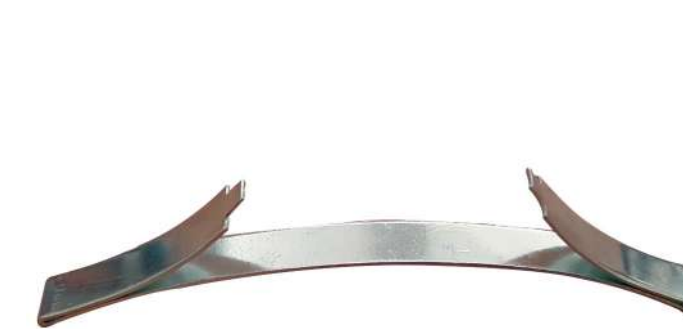

ŠIFRA ARTIKLA	OPIS ARTIKLA	J.M.	BOJA
KGPE	Nosač za GOLA profil, metalni	Kom.	Metal



ŠIFRA ARTIKLA	OPIS ARTIKLA	J.M.	BOJA
KGPP	Nosač za GOLA profil, plastični	Kom.	Siva



ŠIFRA ARTIKLA	OPIS ARTIKLA	J.M.	BOJA
6284	Profil LED, L-3m, ugradbeni	Set	Eloxal
6284BM	Profil LED, L-3m, crni, ugradbeni	Set	Crna

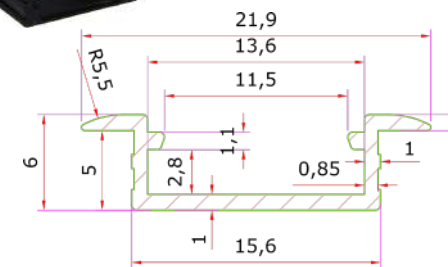

ŠIFRA ARTIKLA	OPIS ARTIKLA	J.M.	BOJA
6285	Profil LED, 3m, nadgradni	Set	Eloxal
6285BM	Profil LED, 3m, crni, nadgradni	Set	Crna

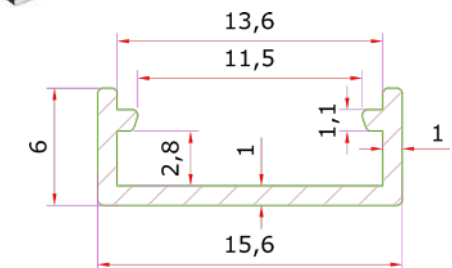

ŠIFRA ARTIKLA	OPIS ARTIKLA	J.M.	BOJA
DLP3B	Difuzor za LED traku, bijeli, L-3m	Set	Bijela
DLP3T	Difuzor za LED traku, transparentni, L-3m	Set	Transparent



ČETKICE ZA ALUMINIJSKE RUKOHVATE

ŠIFRA ARTIKLA	OPIS ARTIKLA	J.M.	BOJA
CAP070	Uvlačna četkica za rukohvat , 7x5mm	m	Siva
CAP070W	Uvlačna četkica za rukohvat , 7x5mm , BIJELA	m	Bijela
CAP070B	Uvlačna četkica za rukohvat , 7x5mm , CRNA	m	Crna
CAPS071	Četkica za rukohvat , samoljepljiva , 7x5mm	m	Siva
CAP072W	Četkica uvlačna široka WIDE 14*6mm, BIJELA	m	Bijela
CAP072	Četkica uvlačna široka WIDE 14*6mm	m	Siva



KOTAČI ZA KLIZNE SISTEME

ŠIFRA ARTIKLA	OPIS ARTIKLA	J.M.	
KMG098	Točkić, gornji	Kom.	2



ŠIFRA ARTIKLA	OPIS ARTIKLA	J.M.	
KMDU099	Točkić, donji upadajući	Kom.	2



ŠIFRA ARTIKLA	OPIS ARTIKLA	J.M.	
KMDN100	Točkić , donji , naklapajući	Kom.	2



ŠIFRA ARTIKLA	OPIS ARTIKLA	J.M.	
KM104	Kotači (2 donja+2 gornja) , upadajući	Kom.	2



ŠIFRA ARTIKLA	OPIS ARTIKLA	J.M.	
KM105	Kotači (4donja + 4gornja), upadajući	Set	20



ŠIFRA ARTIKLA	OPIS ARTIKLA	J.M.	
KM105V	Kotači (2 donja + 2 gornja) , upadajući	Set	40



ŠIFRA ARTIKLA	OPIS ARTIKLA	J.M.	
KM107	Kotači, ispuna 18mm	Set	100



ŠIFRA ARTIKLA	OPIS ARTIKLA	J.M.	
KM106	Kotači, ispuna 10mm	Set	100



ŠIFRA ARTIKLA	OPIS ARTIKLA	J.M.	
KDS1H	Kotač donji, SPRING	Kom.	100



ŠIFRA ARTIKLA	OPIS ARTIKLA	J.M.	
KGS1H	Kotač gornji, SOLID PLUS	Kom.	100



ŠIFRA ARTIKLA	OPIS ARTIKLA	J.M.	
---------------	--------------	------	---

K2V Set kotača za dvoja vrata, RMC Set 24

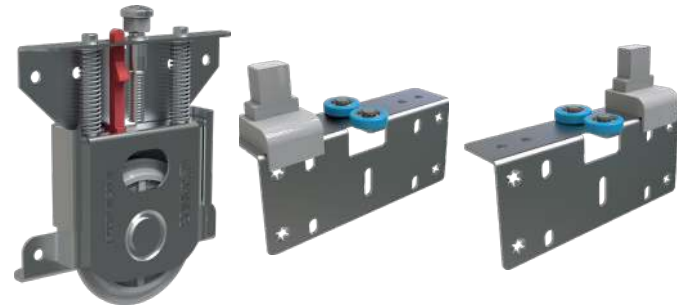

ŠIFRA ARTIKLA	OPIS ARTIKLA	J.M.	
---------------	--------------	------	---

K2VC Set kotača za dvoja vrata, CONAX Set 24

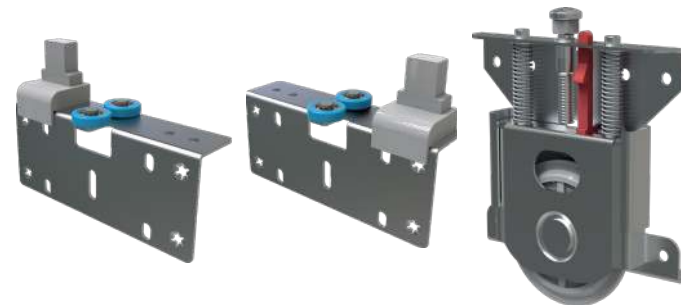

ŠIFRA ARTIKLA	OPIS ARTIKLA	J.M.	
---------------	--------------	------	---

K1VP Set kotača za jedna vrata, sa ublaživačem, PREMIUM Set 24

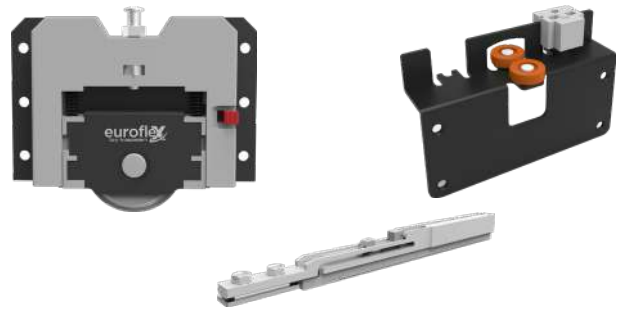

ŠIFRA ARTIKLA	OPIS ARTIKLA	J.M.	
---------------	--------------	------	---

GVSP Gornja vodilica za klizni sistem PREMIUM - CONAX m 6

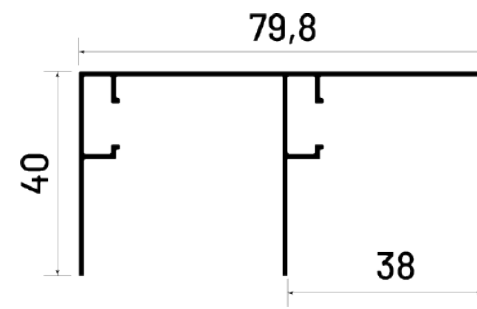

ŠIFRA ARTIKLA	OPIS ARTIKLA	J.M.	
---------------	--------------	------	---

AW109 Amortizer "Wingo" Set 5



ŠIFRA ARTIKLA	OPIS ARTIKLA	J.M.	
---------------	--------------	------	---

YFS204 Ublaživač Soft Close 40 kg Kom. 100



ŠIFRA ARTIKLA	OPIS ARTIKLA	J.M.	
---------------	--------------	------	---

YFS202 Ublaživač, Soft Close, 60-80 kg Kom. 100



ŠIFRA ARTIKLA	OPIS ARTIKLA	J.M.	
---------------	--------------	------	---

YFS203 Ublaživač Soft Close 60-80 kg, metalno kućište Kom. 100



ŠIFRA ARTIKLA	OPIS ARTIKLA	J.M.	
---------------	--------------	------	---

L-1258-8 Ublaživač za sistem LC58 - Lucido Kom. 50



ŠIFRA ARTIKLA	OPIS ARTIKLA	J.M.	
---------------	--------------	------	---

L-4110 Ublaživač za sistem LC75 - Lucido Kom. 50



ŠIFRA ARTIKLA	OPIS ARTIKLA	J.M.	
GIC250	Izvlačna vješalica , L-250mm , EXTRA	Kom.	8
GIC300	Izvlačna vješalica , L-300mm , EXTRA	Kom.	8
GIC350	Izvlačna vješalica , L-350mm , EXTRA	Kom.	8
GIC400	Izvlačna vješalica , L-400mm , EXTRA	Kom.	8
GIC450	Izvlačna vješalica , L-450mm , EXTRA	Kom.	8



ŠIFRA ARTIKLA	OPIS ARTIKLA	J.M.	
GIR250	Garderobni izvlačak sa ručkom za izvlačenje 250mm	Kom.	20
GIR350	Garderobni izvlačak sa ručkom za izvlačenje 350mm	Kom.	20



ŠIFRA ARTIKLA	OPIS ARTIKLA	J.M.	
PO041	Cijev za ormar , ovalna , L-3m , kromirana	Kom.	10



ŠIFRA ARTIKLA	OPIS ARTIKLA	J.M.	
PO25	Cijev za ormar , okrugla , L-3m , Ø25mm , kromirana	Kom.	10



ŠIFRA ARTIKLA	OPIS ARTIKLA	J.M.	
NP045	Nosač ovalne cijevi	Par	500



ŠIFRA ARTIKLA	OPIS ARTIKLA	J.M.	
NP043	Nosač ovalne cijevi , plafonski	Kom	100



ŠIFRA ARTIKLA	OPIS ARTIKLA	J.M.	
NP025	Nosač okrugle cijevi , Ø25mm	Par	250



ŠIFRA ARTIKLA	OPIS ARTIKLA	J.M.	
NOP1530	Nosač ovalne palice , 15x30 mm , srednji	Kom.	100
NPH1530	Nosač ovalne palice , 15x30 mm , zatvoreni	Kom.	100



ŠIFRA ARTIKLA	OPIS ARTIKLA	J.M.	
NPB	Nosač ovalne palice sa pokrivkom , bjeli , PVC	Par	50



ŠIFRA ARTIKLA	OPIS ARTIKLA	J.M.	
LL3B	Letva ledna , PVC , L - 3000mm , bijela	Kom.	20

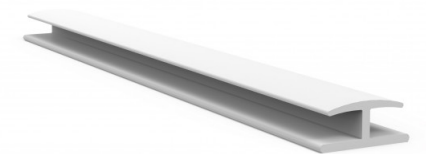

ŠIFRA ARTIKLA	OPIS ARTIKLA	J.M.	
SV1	Minifix , stezni vijak , 34mm , direktno u ivericu	Kom	5000
SV2	Minifix , stezni vijak , 34mm , mašinski navoj	Kom	5000
SV3	Minifix , stezni vijak , 24mm , direktno u ivericu	Kom	5000



ŠIFRA ARTIKLA	OPIS ARTIKLA	J.M.	
MF18	Minifix , glava za 16mm	Kom.	5000
MF16	Minifix , glava za 18mm	Kom.	5000



ŠIFRA ARTIKLA	OPIS ARTIKLA	J.M.	
ESVM139	Ekscentar - stezni vijak - PVC matica , 100/1	cet	10



ŠIFRA ARTIKLA	OPIS ARTIKLA	J.M.	
PTM6811	Plastična tipla , Ø8x10 , M6	Kom.	100



ŠIFRA ARTIKLA	OPIS ARTIKLA	J.M.	
VK550H	Konfirmat vijak , Ø5x50mm, 200/1	Box	20
VK75136	Vijak konfirmat , 70X50mm , 100/1	Box	15



ŠIFRA ARTIKLA	OPIS ARTIKLA	J.M.	
SV140	Stezni vijak , 7.4X30mm , 100/1	Set	100



ŠIFRA ARTIKLA	OPIS ARTIKLA	J.M.	
KBVK4	Pokrivna kapica za konfirmat vijak , Ø4mm , bijela	cet	100



ŠIFRA ARTIKLA	OPIS ARTIKLA	J.M.	
DT830	Drvena tipla 8x30mm	kg	1
CMG001	Lamela-keks 20 , 1000/1	BOX	1



ŠIFRA ARTIKLA	OPIS ARTIKLA	J.M.	
VI3516F	Iver vijak 3,5x16mm, DIN 7505, 500/1	box	100
VI3518F	Vijak Iver 3,5x18mm DIN 7505 500/1	box	500
VI3530F	Iver vijak DIN 7505, 3,50x30mm, Zn 200/1	box	200
VI3550F	Iver vijak DIN 7505, 3,50x50mm, Zn 200/1	box	200
VI416F	Iver vijak DIN 7505, 4,0x16 mm, Zn 500/1	box	500
VI418F	Iver vijak DIN 7505, 4,0x18 mm, Zn 500/1	box	500
VI420F	Vijak Iver DIN7505, 4,0x20 mm Zn 200/1	box	200
VI425F	Vijak Iver DIN7505, 4,0x25 mm Zn 200/1	box	200
VI430F	Iver vijak DIN 7505, 4,0x30mm, Zn 200/1	box	200
VI435F	Iver vijak DIN 7505, 4x35mm, Zn 200/1	box	200
VI440F	Iver vijak DIN 7505, 4,0x40mm, Zn 100/1	box	100
VI445F	Iver vijak DIN 7505, 4,0x45mm, Zn 100/1	box	100
VI450F	Iver vijak DIN 7505, 4,0x50mm, Zn 100/1	box	100
VI460F	Iver vijak DIN 7505, 4,0X60mm,Zn 100/1	box	100
VI530F	Iver vijak DIN 7505, 5,0x30 mm, Zn 100/1	box	100
VI535F	Iver vijak , DIN 7505, 5,0x35mm, Zn 100/1	box	100
VI540F	Iver vijak DIN 7505, 5,0x40mm, Zn 100/1	box	100
VI560F	Iver vijak DIN 7505, 5,0x60mm, Zn 100/1	box	100
VI580F	Iver vijak DIN 7505, 5,0X80mm, Zn 100/1	box	100
VI640F	Iver vijak DIN 7505, 6,0x40mm, Zn 100/1	box	100
VI660F	Iver vijak DIN 7505, 6,0x60mm Zn 100/1	box	100
VI680F	Iver vijak DIN 7505, 6,0x80mm, Zn 100/1	box	100



SAMOLJEPLJIVE POKRIVNE KAPICE ZA VIJKE

ŠIFRA ARTIKLA	OPIS ARTIKLA	J.M.
PC2100	Pokrivna kapica , Ø14mm , bukva	list
PC2120	Pokrivna kapica , Ø14mm , hrast	list
PC2121	Pokrivna kapica , Ø14mm , halifax hrast	list
PC2122	Pokrivna kapica , Ø14mm , nebraska hrast	list
PC2126	Pokrivna kapica , Ø14mm , sonoma hrast	list
PC2131	Pokrivna kapica , Ø14mm , prir.hrast	list
PC2173	Pokrivna kapica , Ø14mm , orah	list
PC2180	Pokrivna kapica , Ø14mm , wenge	list
PC2195	Pokrivna kapica , Ø14mm , tik	list
PC2305	Pokrivna kapica , Ø14mm , bijela VS	list
PC2310	Pokrivna kapica , Ø14mm , krem VS	list
PC2325	Pokrivna kapica , Ø14mm , crna VS	list
PC2500	Pokrivna kapica , Ø14mm , bijela	list
PC2501	Pokrivna kapica , Ø14mm , bijela lak	list
PC2502	Pokrivna kapica , Ø14mm , bijela mliječna	list
PC2504	Pokrivna kapica , Ø18mm , bijela	list
PC2505	Pokrivna kapica , Ø14mm , bež	list
PC2506	Pokrivna kapica , Ø18mm , bijela lak	list
PC2507	Pokrivna kapica , Ø14mm , krem	list
PC2510	Pokrivna kapica , Ø14mm , crna	list
PC2540	Pokrivna kapica , Ø14mm , metalic siva	list
PC2545	Pokrivna kapica , Ø14mm , siva	list
PC2546	Pokrivna kapica , Ø14mm , antracit	list
PC2548	Pokrivna kapica , Ø18mm , antracit	list
PC2549	Pokrivna kapica , Ø18mm , siva	list

ŠIFRA ARTIKLA	OPIS ARTIKLA	J.M.
PC2585	Pokrivna kapica , Ø14mm , svijetli antik	list
PC2590	Pokrivna kapica , Ø14mm , kafeni antik	list
PC2591	Pokrivna kapica , Ø14mm , bijeli antik	list
PC2600	Pokrivna kapica , Ø14mm , staklo antik	list
PC2605	Pokrivna kapica , Ø14mm , kordoba	list
PC2610	Pokrivna kapica , Ø14mm , trend siva	list
PC2620	Pokrivna kapica , Ø14mm , koton vizon	list
PC2626	Pokrivna kapica , Ø14mm , latte	list
PC2630	Pokrivna kapica , Ø14mm , smreka	list
PC2635	Pokrivna kapica , Ø14mm , kamen	list
PC2640	Pokrivna kapica , Ø14mm , ozigo	list
PC2645	Pokrivna kapica , Ø14mm , salerno	list
PC2650	Pokrivna kapica , Ø14mm , larex	list
PC2655	Pokrivna kapica , Ø14mm , norveški bor	list
PC2660	Pokrivna kapica , Ø14mm , amalfi	list



quality of your life



BEZ UBLAŽIVAČA

ŠIFRA ARTIKLA	OPIS ARTIKLA	J.M.
S-1137-C	Apoteka visoka , modul 300 / 230x500x1700-1850	Kom.
S-1139-C	Apoteka visoka , modul 400 / 330x500x1700-1850	Kom.
S-1141-C	Apoteka visoka , modul 500 / 430x500x1700-1850	Kom.



SA UBLAŽIVAČEM

ŠIFRA ARTIKLA	OPIS ARTIKLA	J.M.
S-1819-C	Apoteka visoka,SOFT CLOSE,modul 300 / 230x500x1700-1850	Kom.
S-1821-C	Apoteka visoka,SOFT CLOSE,modul 400 / 330x500x1700-1850	Kom.
S-1823-C	Apoteka visoka,SOFT CLOSE,modul 500 / 430x500x1700-1850	Kom.



ŠIFRA ARTIKLA	OPIS ARTIKLA	J.M.
S-1119-C	Apoteka srednja, modul 300mm / 230x500x1250-1400	Kom.
S-1121-C	Apoteka srednja, modul 400mm / 330x500x1250-140	Kom.



DUPLA APOTEKA

ŠIFRA ARTIKLA	OPIS ARTIKLA	J.M.
S-1221-C	Apoteka srednja, dupla , modul 450 mm / 380 x 510 x 1250-1400	Kom.
S-1228-C	Apoteka visoka , dupla , 530x530x1700-1850 , modul 600	Kom.



SA UBLAŽIVAČEM

ŠIFRA ARTIKLA	OPIS ARTIKLA	J.M.
S-2211-C	Apoteka niska , SOFT CLOSE , 108X470X470 / modul 150	Kom.
S-2213-C	Apoteka niska , SOFT CLOSE , 153X470X470 / modul 200	Kom.
S-2214-C	Apoteka niska , SOFT CLOSE , 205X470X470 / modul 250	Kom.



TANDEM VODILICA - BLUM

ŠIFRA ARTIKLA	OPIS ARTIKLA	J.M.
S-2421-C	Apoteka niska , SOFT CLOSE , TANDEM vodilica "BLUM" , 106X475X495 , desna	Kom.
S-2422-C	Apoteka niska , SOFT CLOSE , TANDEM vodilica "BLUM" , 106X475X495 , lijeva	Kom.
S-2423-C	Apoteka niska , SOFT CLOSE , TANDEM vodilica "BLUM" , 151X475X495 , desna	Kom.
S-2426-C	Apoteka niska , SOFT CLOSE , TANDEM vodilica "BLUM" , 151X475X495 , lijeva	Kom.
S-2424-C	Apoteka niska , SOFT CLOSE , TANDEM vodilica "BLUM" , 203X475X495 , desna	Kom.
S-2427-C	Apoteka niska , SOFT CLOSE , TANDEM vodilica "BLUM" , 203X475X495 , lijeva	Kom.



TANDEM VODILICA - BLUM ANTRACIT

ŠIFRA ARTIKLA	OPIS ARTIKLA	J.M.
S-2421-A	Apoteka niska , SOFT CLOSE , TANDEM vodilica "BLUM" , 106X475X495 , desna-ANTHRACITE	Kom.
S-2422-A	Apoteka niska , SOFT CLOSE , TANDEM vodilica "BLUM" , 106X475X495 , lijeva-ANTHRACITE	Kom.
S-2423-A	Apoteka niska , SOFT CLOSE , TANDEM vodilica "BLUM" , 151X475X495 , desna-ANTHRACITE	Kom.
S-2426-A	Apoteka niska , SOFT CLOSE , TANDEM vodilica "BLUM" , 151X475X495 , lijeva-ANTHRACITE	Kom.
S-2424-A	Apoteka niska , SOFT CLOSE , TANDEM vodilica "BLUM" , 203X475X495 , desna-ANTHRACITE	Kom.
S-2427-A	Apoteka niska , SOFT CLOSE , TANDEM vodilica "BLUM" , 203X475X495 , lijeva-ANTHRACITE	Kom.



PODPULTNA APOTEKA

ŠIFRA ARTIKLA	OPIS ARTIKLA	J.M.
S-2171-C	Podpultna apoteka , sa dvije korpe i držačem boca , 350mm	Kom.
S-2151-C	Podpultna apoteka , 210x500x520 / modul 300	Kom.



DRŽAČI TANJURA I ČAŠA



ŠIFRA ARTIKLA	OPIS ARTIKLA	J.M.
S-4017-C	Držač tanjura i čaša za kuhinjsku ploču, krom	Kom.
S-4017-A	Držač tanjura i čaša za kuhinjsku ploču, antracit	Kom.

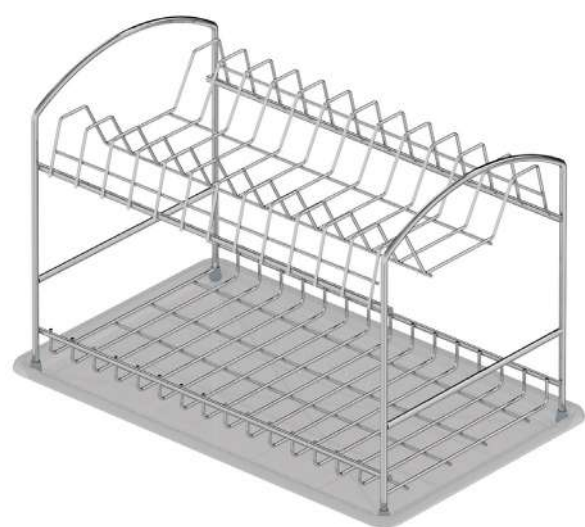

ŠIFRA ARTIKLA	OPIS ARTIKLA	J.M.
S-2233-C	Držač tanjura na teleskopskoj vodilici, 560x470x130 / modul 600	Kom.



MAKSIMALNO ISKORISTITE DRAGOCIJENI PROSTOR.

ŠIFRA ARTIKLA	OPIS ARTIKLA	J.M.
S-3013-C	Kutna izvlačna apoteka, "SECRET CORNER", 850x475x600, modul 450, lijeva, CHROME	Kom.
S-3014-C	Kutna izvlačna apoteka, "SECRET CORNER", 850x475x600, modul 450, desna, CHROME	Kom.

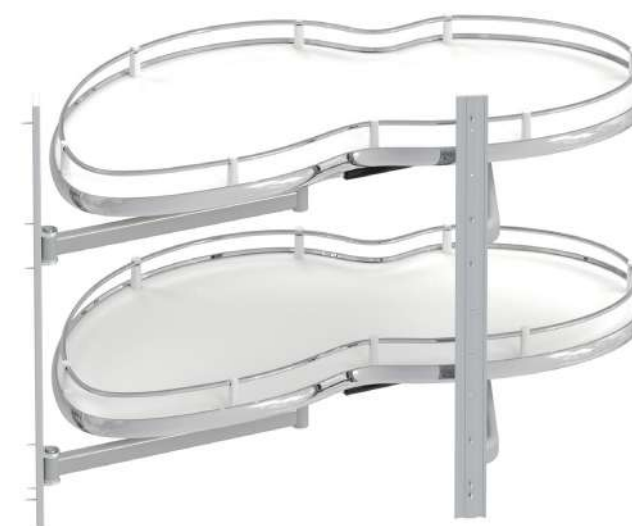

ŠIFRA ARTIKLA	OPIS ARTIKLA	J.M.
S-3001-C	Kutna izvlačna apoteka, DYNAMIC CORNER, lijeva, 860-965 x 530 x 530, modul 450	Kom.
S-3002-C	Kutna izvlačna apoteka, DYNAMIC CORNER, desna, 860-965 x 530 x 530, modul 450	Kom.



MAGIC CORNER

ŠIFRA ARTIKLA	OPIS ARTIKLA	J.M.
S-3005-C	Kutna izvlačna apoteka, "MAGIC CORNER", 600x510x560, modul 400, CHROME	Kom.



ROTO APOTEKE



UGRADBENE LADICE PREMIUM

ŠIFRA ARTIKLA	OPIS ARTIKLA	J.M.
S-3020-C	Roto apoteka, 3/4, Ø600x650-700mm	Kom.
S-3021-C	Roto apoteka, 3/4, Ø740mm	Kom.

ŠIFRA ARTIKLA	OPIS ARTIKLA	J.M.
S-3011-C	Roto apoteka, 1/2, Ø740x420x600-700mm	Kom.

ŠIFRA ARTIKLA	OPIS ARTIKLA	J.M.
S-2333-P-W	PREMIUM ugradbena ladica, na BLUM skrivenim vodilicama sa punom izvlačkom, 450mm, bijela boja	Kom.
S-2334-P-W	PREMIUM ugradbena ladica, na BLUM skrivenim vodilicama sa punom izvlačkom, 500mm, bijela boja	Kom.

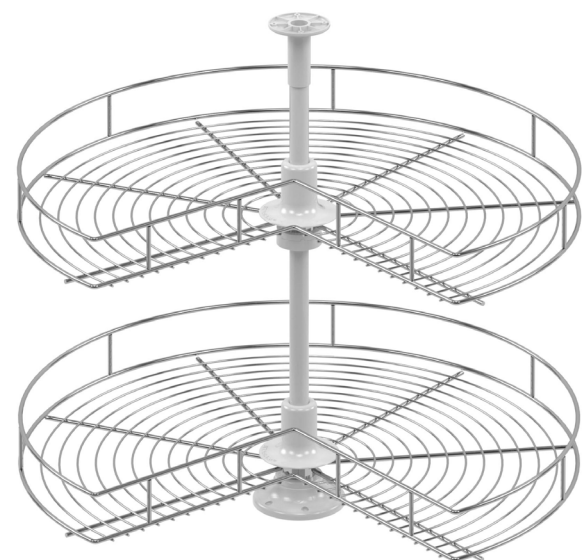

ŠIFRA ARTIKLA	OPIS ARTIKLA	J.M.
S-3033-C	Roto apoteka, 4/4, Ø600x700mm	Kom.
S-3034-C	Roto apoteka, 4/4, Ø750mm	Kom.

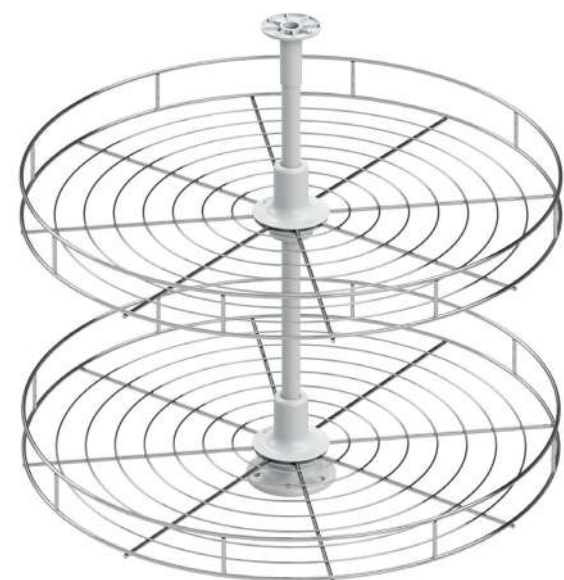

KANTE ZA SMEĆE



ŠIFRA ARTIKLA	OPIS ARTIKLA	J.M.
---------------	--------------	------

S-2391-G Izvlačna kanta za smeće , 260x440x400 , na teleskopskoj vodilici / 16 + 1 Lit. Kom.



ŠIFRA ARTIKLA	OPIS ARTIKLA	J.M.
---------------	--------------	------

S-2392-G Izvlačna kanta za smeće , 260x440x400 , na teleskopskoj vodilici / 12 + 12 Lit. Kom.



ŠIFRA ARTIKLA	OPIS ARTIKLA	J.M.
---------------	--------------	------

S-2385-G Izvlačna kanta za smeće , 564x470x380 , na teleskopskoj vodilici / 41 lit.(16+12+12+1) , Siva Kom.



ŠIFRA ARTIKLA	OPIS ARTIKLA	J.M.
---------------	--------------	------

S-2253-SS Kanta za smeće , automatsko otvaranje , 355x300x380 , 10 Lit. Kom.

S-2253-B Kanta za smeće , automatsko otvaranje , 355x300x380 , 10 Lit. , crna Kom.



ŠIFRA ARTIKLA	OPIS ARTIKLA	J.M.
---------------	--------------	------

S-2300-G Izvlačna kanta za smeće , 364x470x435 , na teleskopskoj vodilici / 35 lit. , Siva Kom.



KANTE ZA SMEĆE

ŠIFRA ARTIKLA	OPIS ARTIKLA	J.M.	
---------------	--------------	------	--

KS15A Kanta za smeće, 15l, sa senzorom za automatsko otvaranje, bijela boja Kom. 12



Kanta za smeće, automatsko otvaranje

Zapremina	15 l
Boja	Bijela
Način rada	na senzor na dodir



KANTE ZA SMEĆE



ŠIFRA ARTIKLA	OPIS ARTIKLA	J.M.
S-2590-A	Izvlačna kanta za smeće, 35 l, Antracit, 263 x 465 x 525mm, Mod.300mm	Kom.



ŠIFRA ARTIKLA	OPIS ARTIKLA	J.M.
S-2575-W	Kanta za smeće, kačenje na frontu, 5l, bijela	Kom.
S-2575-A	Kanta za smeće, kačenje na frontu, 5l, antracit	Kom.



ŠIFRA ARTIKLA	OPIS ARTIKLA	J.M.	
S-6013-G	Garderobni lift, 10 kg, 850-1150x285x900, siva boja	Kom.	6



ŠIFRA ARTIKLA	OPIS ARTIKLA	J.M.	
S-6014-G	Garderobni lift, 15 kg, 850-1150x150x900, siva boja	Kom.	6
S-6014-A	Garderobni lift, 15 kg, 850-1150x150x900, antracit	Kom.	6



ŠIFRA ARTIKLA	OPIS ARTIKLA	J.M.	
S-6012-A	Garderobni lift, 12 kg, 850-1150x130x800, antracit	Kom.	6
S-6012-G	Garderobni lift, 12 kg, 850-1150x130x800, siva boja	Kom.	6



ŠIFRA ARTIKLA	OPIS ARTIKLA	J.M.	
S-6011-G	Garderobni lift, 12kg, 600-850x130x800mm, siva boja	Kom.	6



ŠIFRA ARTIKLA	OPIS ARTIKLA	J.M.	
---------------	--------------	------	---

S-6616-W Sklopivi stol za peglanje , 330x495x150mm , bijeli Kom. 1

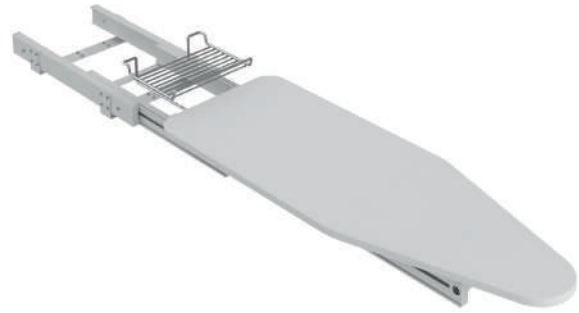

STARAX[®]
quality of your life

ŠIFRA ARTIKLA	OPIS ARTIKLA	J.M.	
---------------	--------------	------	---

S-6611-G Stol za peglanje , izvlačni , 150x340x1480, sivi Kom. 1



ŠIFRA ARTIKLA	OPIS ARTIKLA	J.M.	
---------------	--------------	------	---

S-6619-C Držač pegle , i stola za peglanje , 200x200x380mm, krom Kom. 1

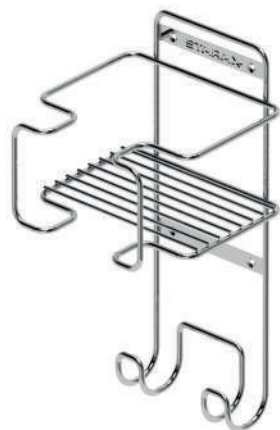

ŠIFRA ARTIKLA	OPIS ARTIKLA	J.M.	
---------------	--------------	------	---

S-6722-A Držač hlača, na teleskopskoj vodilici, antracit Kom. 1



ŠIFRA ARTIKLA	OPIS ARTIKLA	J.M.	
---------------	--------------	------	---

S-6540-G Držač hlača i remena, na teleskopskoj vodilici, siva boja Kom. 1



ŠIFRA ARTIKLA	OPIS ARTIKLA	J.M.	
---------------	--------------	------	---

S-6544-G Držač kravata i remena , na teleskopskoj vodilici, siva boja Kom. 1



ŠIFRA ARTIKLA	OPIS ARTIKLA	J.M.	
---------------	--------------	------	---

S-6057-C Držač kravata i remena, na teleskopskoj vodilici, krom Kom. 1



STARAX[®]
quality of your life



ŠIFRA ARTIKLA	OPIS ARTIKLA	J.M.	
---------------	--------------	------	---

S-6058-C Držać remena, na teleskopskoj vodilici, krom Kom. 1

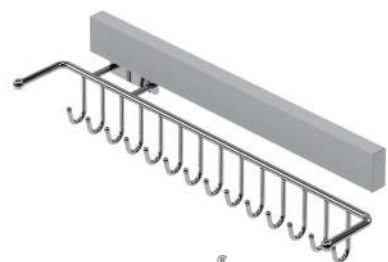

STARAX[®]
quality of your life



ŠIFRA ARTIKLA	OPIS ARTIKLA	J.M.	
---------------	--------------	------	---

S-6709-A Držać hlača, tandem vodilica, antracit, 80 cm Kom. 1



ŠIFRA ARTIKLA	OPIS ARTIKLA	J.M.	
---------------	--------------	------	---

S-6307-G Držać hlača, na teleskopskoj vodilici, PVC, 80 cm, siva boja Kom. 1

S-6307-A Držać hlača, na teleskopskoj vodilici, PVC, 80 cm, antracit boja Kom. 1

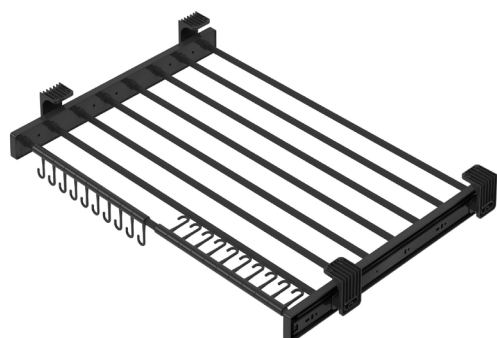

ŠIFRA ARTIKLA	OPIS ARTIKLA	J.M.	
---------------	--------------	------	---

S-8013-C Korpa za rublje, ugradbena na frontu, 40cm Kom. 1

S-8015-C Korpa za rublje, ugradbena na frontu, 50cm Kom. 1

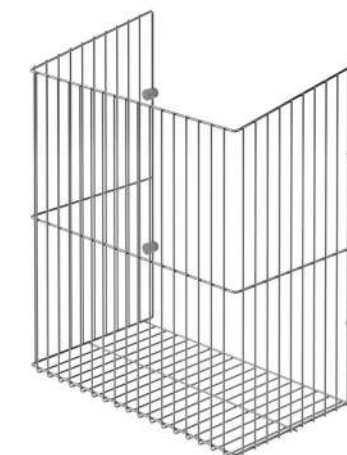

ŠIFRA ARTIKLA	OPIS ARTIKLA	J.M.	
---------------	--------------	------	---

CON004 Okov za cipelar , SINGLE Kom. 1

CON005 Okov za cipelar , DOUBLE Kom. 1

CON006 Okov za cipelar , TRIPLE Kom. 1



KUHINJSKE NAPE



ŠIFRA ARTIKLA	OPIS ARTIKLA	J.M.
NAP8054X	Napa kuhinjska, 8054, INOX	Kom.



Ugradbena teleskopska napa, 80cm	
Motor	2x 110w
Osvjetljenje	5W LED
Ventilacioni izlaz	120mm
Način rada	3 brzine



ŠIFRA ARTIKLA	OPIS ARTIKLA	J.M.
NAPGD52X	Napa kuhinjska GD52X, INOX	Kom.



Ugradbena napa, 52cm	
Motor	140W
Osvjetljenje	2x LED svjetlo
Ventilacioni izlaz	150mm
Način rada	3 brzine

ŠIFRA ARTIKLA	OPIS ARTIKLA	J.M.
NAP8054C	Napa kuhinjska 8054 crna boja	Kom.



Ugradbena teleskopska napa, 80cm	
Motor	2x 110w
Osvjetljenje	5W LED
Ventilacioni izlaz	120mm
Način rada	3 brzine

ŠIFRA ARTIKLA	OPIS ARTIKLA	J.M.	
F8054X	Ugljeni filteri za napu 8054, 2/1	Par	1



ŠIFRA ARTIKLA	OPIS ARTIKLA	J.M.	
097	Ventilaciona redukcija fi 100/ fi 118	Kom.	1
158	Ventilaciona redukcija fi 120/ fi 150	Kom.	1
174	Ventilaciona redukcija FI/80, FI/100, FI/110, FI/120, FI/125, FI/150	Kom.	1



ŠIFRA ARTIKLA	OPIS ARTIKLA	J.M.	
FC1201	Fleksibilno alu crijevo , Ø 120 mm , 1m	Kom.	1
FC1202	Fleksibilno alu crijevo , Ø 120 mm , 2m	Kom.	1
FC1203	Fleksibilno alu crijevo , Ø 120 mm , 3m	Kom.	1



ŠIFRA ARTIKLA	OPIS ARTIKLA	J.M.	
FC1201W	Fleksibilno alu crijevo , Ø 120 mm , 1m , bijelo	Kom.	1
FC1202W	Fleksibilno alu crijevo , Ø 120 mm , 2m , bijelo	Kom.	1
FC1203W	Fleksibilno alu crijevo , Ø 120 mm , 3m , bijelo	Kom.	1



ŠIFRA ARTIKLA	OPIS ARTIKLA	J.M.	
FC1501	Fleksibilno alu crijevo , Ø 150 mm , 1m	Kom.	1
FC1502	Fleksibilno alu crijevo , Ø 150 mm , 2m	Kom.	1
FC1503	Fleksibilno alu crijevo , Ø 150 mm , 3m	Kom.	1



SUDOPERI I SIFONI



ŠIFRA ARTIKLA	OPIS ARTIKLA	J.M.	
---------------	--------------	------	--

SUBL871 Sudoper "RONDO", 460x460x185mm Kom. 10



INOX 201

Uz ovaj sudoper u setu dolaze žabice i dihtung.

ŠIFRA ARTIKLA	OPIS ARTIKLA	J.M.	
---------------	--------------	------	--

SUBL857 Sudoper "GOX", 510x510x185mm Kom. 10



INOX 201

Uz ovaj sudoper u setu dolaze žabice i dihtung.



ŠIFRA ARTIKLA	OPIS ARTIKLA	J.M.	
---------------	--------------	------	--

SUBL859 Sudoper "UNA", 770x500x200mm Kom. 10



INOX 201

Uz ovaj sudoper u setu dolaze žabice i dihtung.

ŠIFRA ARTIKLA	OPIS ARTIKLA	J.M.	
---------------	--------------	------	--

SUBL834 Sudoper "GRAND", 800x480x180mm Kom. 10



INOX 201

Uz ovaj sudoper u setu dolaze žabice i dihtung.

ŠIFRA ARTIKLA	OPIS ARTIKLA	J.M.	
---------------	--------------	------	--

SNBL864L Sudoper nasadni lijevi "MONTY", 800x600x190mm Kom. 5
 SNBL864R Sudoper nasadni desni "MONTY", 800x600x190mm Kom. 5



INOX 201

ŠIFRA ARTIKLA	OPIS ARTIKLA	J.M.	
---------------	--------------	------	--

SUBL905 Sudoper "CONT", L/D, 780x430x165mm Kom. 10



INOX 201

Uz ovaj sudoper u setu dolaze žabice i dihtung.

ŠIFRA ARTIKLA	OPIS ARTIKLA	J.M.	
---------------	--------------	------	--

SKBL872 Sudoper kutni "CORNER", 950x500x185mm Kom. 10



INOX 201

Uz ovaj sudoper u setu dolaze žabice i dihtung.

ŠIFRA ARTIKLA	OPIS ARTIKLA	J.M.	
---------------	--------------	------	--

SUBL619 Sudoper "QUADRIX", 490x470x185mm Kom. 10



INOX 201

Uz ovaj sudoper u setu dolaze žabice i dihtung.

ŠIFRA ARTIKLA	OPIS ARTIKLA	J.M.	
---------------	--------------	------	---

1081921	Sifon za sudoper , FLEX	Kom.	35
---------	-------------------------	------	----



ŠIFRA ARTIKLA	OPIS ARTIKLA	J.M.	
---------------	--------------	------	---

1081922	Sifon Form 50, Flex, 2/2 fi 114	Kom.	10
---------	---------------------------------	------	----



ŠIFRA ARTIKLA	OPIS ARTIKLA	J.M.	
---------------	--------------	------	---

960203	Sifon za dvodjelne sudopere, prelivno grlu fi114	Kom.	10
--------	--	------	----



KUHINJSKE SLAVINE

CONGO

ŠIFRA ARTIKLA	OPIS ARTIKLA	J.M.	
---------------	--------------	------	---

SL3F	Kuhinjska slavina FLEXY , inox	Kom.	12
------	--------------------------------	------	----

SL3FC	Kuhinjska slavina FLEXY , crna	Kom.	12
-------	--------------------------------	------	----

FLEKSIBILNO CRIJEVO MAGNETNI PRIHVAT TUŠ



ŠIFRA ARTIKLA	OPIS ARTIKLA	J.M.	
---------------	--------------	------	---

SL1C	Kuhinjska slavina LARA , crna	Kom.	12
------	-------------------------------	------	----

SL1S	Kuhinjska slavina LARA , inox	Kom.	12
------	-------------------------------	------	----

SL1B	Kuhinjska slavina LARA , bijela	Kom.	12
------	---------------------------------	------	----



ŠIFRA ARTIKLA	OPIS ARTIKLA	J.M.	
---------------	--------------	------	---

SL6F	Kuhinjska slavina TEA, inox	Kom.	12
------	-----------------------------	------	----

FLEKSIBILNO CRIJEVO MAGNETNI PRIHVAT TUŠ



ŠIFRA ARTIKLA	OPIS ARTIKLA	J.M.	
---------------	--------------	------	---

SL5C	Kuhinjska slavina FLOW, crna	Kom.	12
------	------------------------------	------	----

SL5B	Kuhinjska slavina FLOW, bijela	Kom.	12
------	--------------------------------	------	----

SL5S	Kuhinjska slavina FLOW, siva	Kom.	12
------	------------------------------	------	----

FLEKSIBILNO CRIJEVO





ALVEUS



ŠIFRA ARTIKLA	OPIS ARTIKLA	J.M.	
1090942	Sudoper, A ROCK 130, Boja-CARBON	Kom.	1



ŠIFRA ARTIKLA	OPIS ARTIKLA	J.M.	
1130330	Sudoper, A RECORD 30, Boja-BEŽ	Kom.	1



ŠIFRA ARTIKLA	OPIS ARTIKLA	J.M.	
1147565	Sudoper A GEM 10, Boja-CARBON	Kom.	1



ŠIFRA ARTIKLA	OPIS ARTIKLA	J.M.	
1147567	Sudoper A GEM 20, Boja-CARBON	Kom.	1



ŠIFRA ARTIKLA	OPIS ARTIKLA	J.M.	
1131996	Sudoper, A ATROX 30, Boja - CARBON	Kom.	1



ŠIFRA ARTIKLA	OPIS ARTIKLA	J.M.	
1117050	Sudoper, INTERMEZZO 130, Boja - CARBON	Kom.	1



ŠIFRA ARTIKLA	OPIS ARTIKLA	J.M.	
---------------	--------------	------	---

1133430 Sudoper GENESIS Boogie, 10, Boja - CARBON Kom. 1



ŠIFRA ARTIKLA	OPIS ARTIKLA	J.M.	
---------------	--------------	------	---

1106867 Sudoper, PURE 30 MONARCH, Boja - GOLD Kom. 1



ŠIFRA ARTIKLA	OPIS ARTIKLA	J.M.	
---------------	--------------	------	---

1065164 Sudoper, FORM 30 Kom. 1



ŠIFRA ARTIKLA	OPIS ARTIKLA	J.M.	
---------------	--------------	------	---

1066750 Sudoper, LINE 80 790X500mm, fi-114 Kom. 1



ŠIFRA ARTIKLA	OPIS ARTIKLA	J.M.	
---------------	--------------	------	---

1129076 Dozator CALLAS 0,32l, Boja-CARBON Kom. 1

1129074 Dozator CALLAS , 0,32lit , boja G-11 Arctic Kom. 1

1129075 Dozator CALLAS, 0,32l, Boja - Bež Kom. 1



ŠIFRA ARTIKLA	OPIS ARTIKLA	J.M.	
---------------	--------------	------	---

1136662 ALL ROUND Mini Rešetka Kom. 1

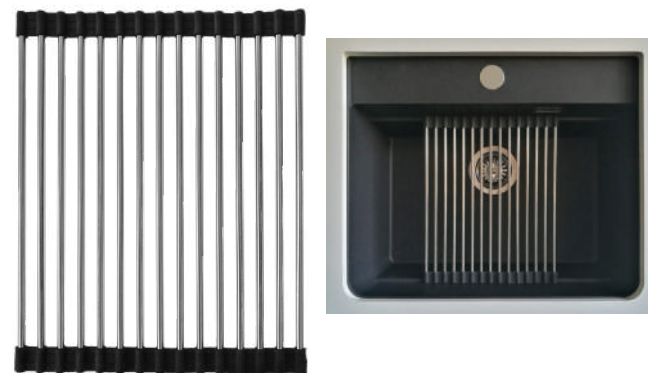

ŠIFRA ARTIKLA	OPIS ARTIKLA	J.M.	
---------------	--------------	------	---

LTA195B LED traka RGB, 5m, sa adapterom i daljinskim upravljačem Kom. 1



ŠIFRA ARTIKLA	OPIS ARTIKLA	J.M.	
---------------	--------------	------	---

LT5M LED traka , 5m, bijela boja Kom. 1



ŠIFRA ARTIKLA	OPIS ARTIKLA	J.M.	
---------------	--------------	------	---

LT3USB USB Led traka, RGB, 3m, sa daljinskim upravljačem i mobilnom aplikacijom Kom. 1



ŠIFRA ARTIKLA	OPIS ARTIKLA	J.M.	
---------------	--------------	------	---

LT5RGB Led traka, 5m, RGB, sa daljinskim upravljačem i adapterom Kom. 1



ŠIFRA ARTIKLA	OPIS ARTIKLA	J.M.	
---------------	--------------	------	---

ADL5M Adapter za LED traku Kom. 1



ŠIFRA ARTIKLA	OPIS ARTIKLA	J.M.	
---------------	--------------	------	---

NSL Naglavna svetiljka, LED Kom. 1



ŠIFRA ARTIKLA	OPIS ARTIKLA	J.M.	
---------------	--------------	------	---

UU04C Ugradbena utičnica sa podrškom za bežično punjenje 2xSchuko, 1xUSB A, 1xUSB C Kom. 1



ŠIFRA ARTIKLA	OPIS ARTIKLA	J.M.	
---------------	--------------	------	---

UU05 Ugradbena utičnica, 2xSchuko, 2xUSB Klizni poklopac Kom. 1



UGRADBENE UTIČNICE

ŠIFRA ARTIKLA	OPIS ARTIKLA	J.M.	
---------------	--------------	------	---

UU02 Ugradbena električna utičnica , sa 3 utičnice i USB priključkom Kom. 1



ŠIFRA ARTIKLA	OPIS ARTIKLA	J.M.	
---------------	--------------	------	---

UU02C Ugradbena električna utičnica , sa 3 utičnice , CRNA Kom. 1



ŠIFRA ARTIKLA	OPIS ARTIKLA	J.M.	
---------------	--------------	------	---

UU03 Ugradbena električna utičnica, kvadratna, sa 2 utičnice i USB priključkom Kom. 1



ŠIFRA ARTIKLA	OPIS ARTIKLA	J.M.	
---------------	--------------	------	---

UU03C Ugradbena električna utičnica , kvadratna , sa 3 utičnice, crna Kom. 1



ŠIFRA ARTIKLA	OPIS ARTIKLA	J.M.	
---------------	--------------	------	---

UU06C Ugradbena desktop utičnica 2xUSB A, 1xUSB C Kom. 1



ŠIFRA ARTIKLA	OPIS ARTIKLA	J.M.	
---------------	--------------	------	---

UU07C Ugradbena utičnica, 1x Schuko, 1xUSB A, 1xUSB C Kom. 1



ŠIFRA ARTIKLA	OPIS ARTIKLA	J.M.	
RB001B	Rozetna okrugla za kablove , bijela	Kom.	40
RB001S	Rozetna okrugla za kablove , siva	Kom.	40
RB001C	Rozetna okrugla za kablove , crna	Kom.	40



ŠIFRA ARTIKLA	OPIS ARTIKLA	J.M.	
R002	Rozetna za kablove , PVC , saten	Kom.	10



ŠIFRA ARTIKLA	OPIS ARTIKLA	J.M.	
PK80160	Provodnik za kablove, sa četkicom, 80x160mm, sivi	Kom.	10
PK8080	Provodnik za kablove, sa četkicom, 80x80mm, sivi	Kom.	10



ŠIFRA ARTIKLA	OPIS ARTIKLA	J.M.	
KRK03	Kvaka, mod.03, sa rozetnom, inox - ključ	Set	20
KRC03	Kvaka, mod.03, sa rozetnom, inox - cilindar	Set	20
KRW03	Kvaka, mod.03, sa rozetnom, inox - WC	Set	20



ŠIFRA ARTIKLA	OPIS ARTIKLA	J.M.	
KRK04C	Kvaka, mod.04, sa rozetnom ključ, crna	Set	20
KRC04C	Kvaka, mod.04, sa rozetnom cilindar, crna	Set	20
KRW04C	Kvaka, mod.04, sa rozetnom WC, crna	Set	20

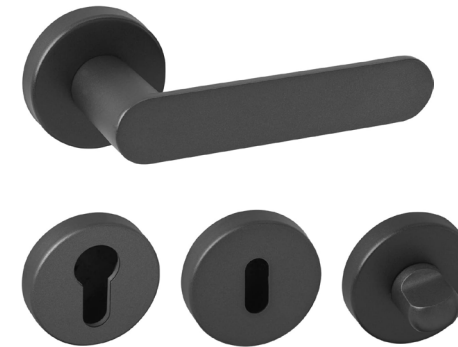

ŠIFRA ARTIKLA	OPIS ARTIKLA	J.M.	
KRK04	Kvaka, mod.04, sa rozetnom ključ, saten	Set	20
KRC04	Kvaka, mod.04, sa rozetnom cilindar, saten	Set	20
KRW04	Kvaka, mod.04, sa rozetnom WC, saten	Set	20



ŠIFRA ARTIKLA	OPIS ARTIKLA	J.M.	
KRK05	Kvaka, mod.05, sa rozetnom, inox - ključ	Set	20
KRC05	Kvaka, mod.05, sa rozetnom, inox - cilindar	Set	20
KRW05	Kvaka, mod.05, sa rozetnom, inox - WC	Set	20



ŠIFRA ARTIKLA	OPIS ARTIKLA	J.M.	
KRK06C	Kvaka, mod.06, sa rozetnom ključ, crna	Set	20
KRC06C	Kvaka, mod.06, sa rozetnom cilindar, crna	Set	20
KRW06C	Kvaka, mod.06, sa rozetnom WC, crna	Set	20



ŠIFRA ARTIKLA	OPIS ARTIKLA	J.M.	
SVS02	Spona za vrata , 2mm , saten	Par	50

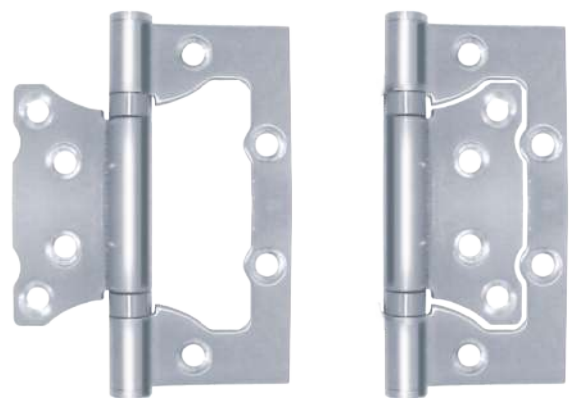

ŠIFRA ARTIKLA	OPIS ARTIKLA	J.M.	
SVS03	Spona za vrata, Korral, 2mm - saten	Par	240



ŠIFRA ARTIKLA	OPIS ARTIKLA	J.M.	
UV2	Štitnik vrata, bijeli, 2/1	Par	1



ŠIFRA ARTIKLA	OPIS ARTIKLA	J.M.	
ZR027	Zasun ravni, s prihvatnikom	Kom.	100



ŠIFRA ARTIKLA	OPIS ARTIKLA	J.M.	
PC2872	Odbojnik za ručku na vratima transparent, 5/1	Set	1



ŠIFRA ARTIKLA	OPIS ARTIKLA	J.M.	
VR2	Ventilaciona rešetka , 80x200mm , aluminijum	Kom.	20
VR3	Ventilaciona rešetka , 80x300mm , aluminijum	Kom.	20
VR4	Ventilaciona rešetka , 80x400mm , aluminijum	Kom.	20
VR5	Ventilaciona rešetka , 80x500mm , aluminijum	Kom.	20

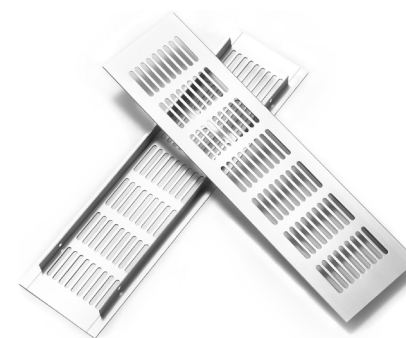

ŠIFRA ARTIKLA	OPIS ARTIKLA	J.M.	
VR2C	Ventilaciona rešetka , 80x200mm crna boja	Kom.	20
VR3C	Ventilaciona rešetka , 80x300mm , crna boja	Kom.	20
VR4C	Ventilaciona rešetka , 80x400mm , crna boja	Kom.	20
VR5C	Ventilaciona rešetka , 80x500mm , crna boja	Kom.	20

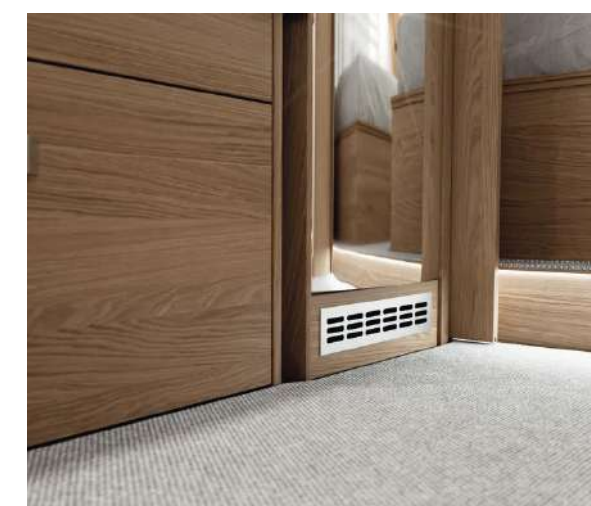

ŠIFRA ARTIKLA	OPIS ARTIKLA	J.M.	
VRI35135	Ventilaciona rešetka , fi35mm , inox	Kom.	100

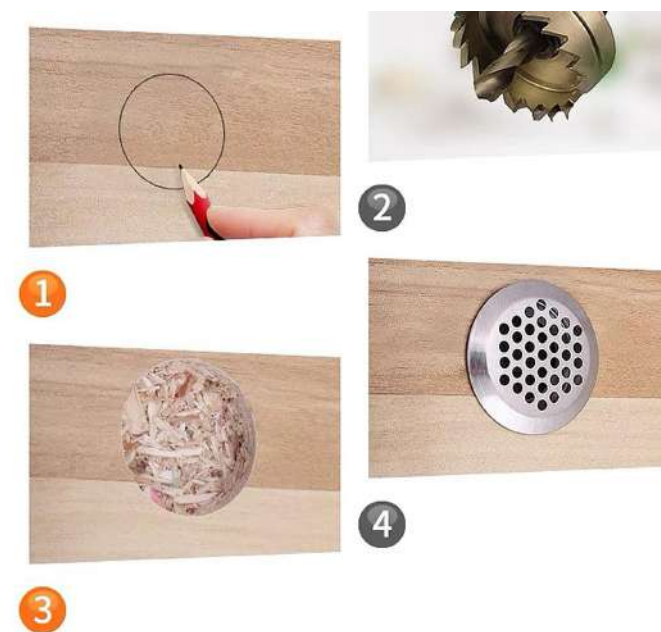



ŠIFRA ARTIKLA	OPIS ARTIKLA	J.M.	
D7000HK	Set za viseća klizna vrata, 2m "BARN DOOR"	Set	1
7000HK	Set za viseća klizna vrata, 2x1.5m "BARN DOOR"	Set	1



ŠIFRA ARTIKLA	OPIS ARTIKLA	J.M.	
SVK2E	Set za viseća klizna vrata, sa ublaživačem, 2m	Set	1



eurolflex
by kapsan



ŠIFRA ARTIKLA	OPIS ARTIKLA	J.M.	
SDS6000	Set za klizna vrata, RMC, 80KG.	Set	38



ŠIFRA ARTIKLA	OPIS ARTIKLA	J.M.	
SDS6000V	Vodilica za viseća / klizna vrata, 2000mm	Set	5

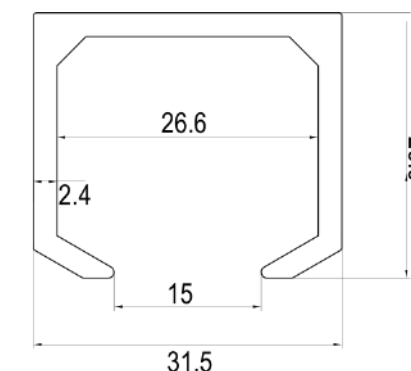

ŠIFRA ARTIKLA	OPIS ARTIKLA	J.M.	
L-1258-7	LC 58 - Set za jedna klizna vrata - Bez ublaživača	Set	1

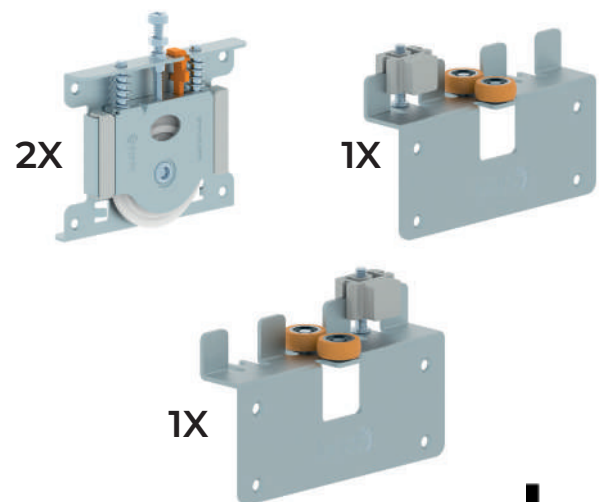

ŠIFRA ARTIKLA	OPIS ARTIKLA	J.M.	
L-1155-9	LC 75-Set za jedna klizna vrata Lucido-bez ublaživača	Set	1

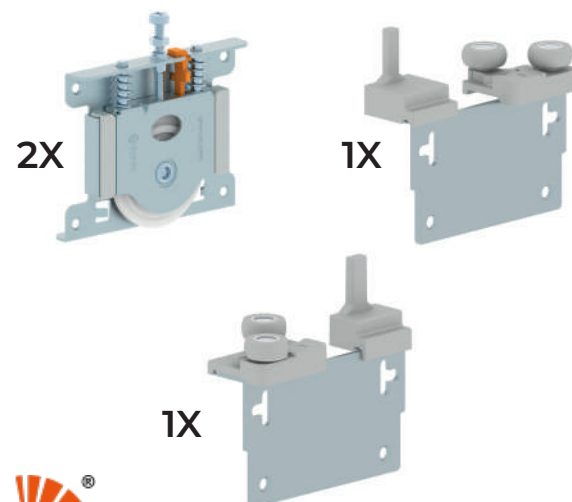

ŠIFRA ARTIKLA	OPIS ARTIKLA	J.M.	
L-3128-1	Vodilica za viseća klizna vrata, LUCIDO, 2000mm	Kom.	1

ŠIFRA ARTIKLA	OPIS ARTIKLA	J.M.	
L-2111	Set kotača za viseća klizna vrata, LUCIDO, 100kg	Set	12

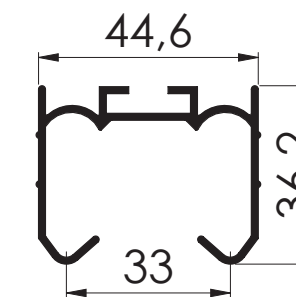
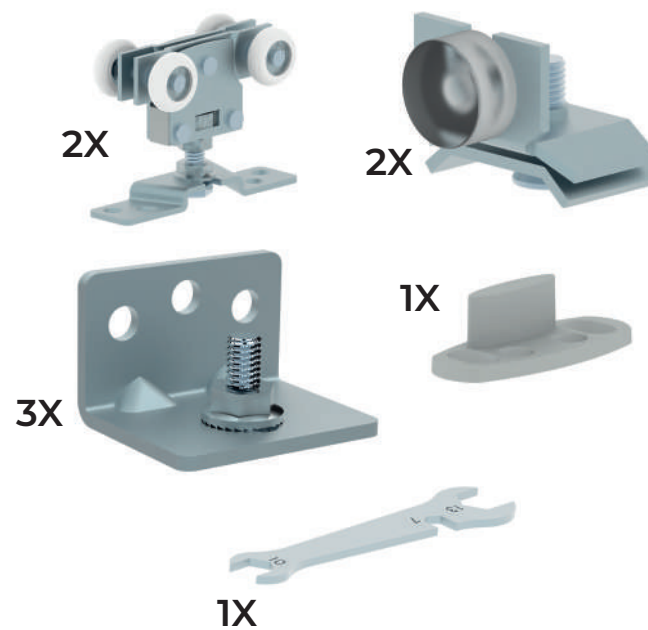

ŠIFRA ARTIKLA	OPIS ARTIKLA	J.M.	
BM030	Bravica za vrata , mod.030	Kom.	12



ŠIFRA ARTIKLA	OPIS ARTIKLA	J.M.	
BM033	Bravica za vrata , mod.033	Kom.	24



ŠIFRA ARTIKLA	OPIS ARTIKLA	J.M.	
BM030G	Bravica za vrata , mod.030 , Gamet	Kom.	24



ŠIFRA ARTIKLA	OPIS ARTIKLA	J.M.	
MS35	Magnet smeđi , 3,5 kg.	Kom.	50
MB35	Magnet bijeli , 3,5 kg.	Kom.	50
MS45	Magnet smeđi , 4,5 kg.	Kom.	50
MB45	Magnet bijeli , 4,5 kg.	Kom.	50
MS55	Magnet smeđi , 5,5 kg.	Kom.	40
MB55	Magnet bijeli , 5,5 kg.	Kom.	40

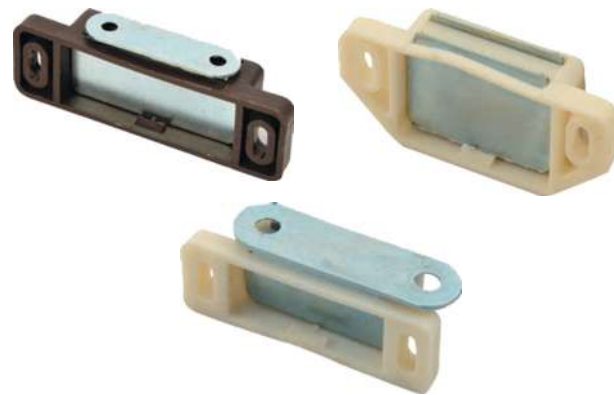

ŠIFRA ARTIKLA	OPIS ARTIKLA	J.M.	
VZS800	Vodilica za stol , 800 mm	Par	10
VZS1000	Vodilica za stol , 1000 mm	Par	10



ŠIFRA ARTIKLA	OPIS ARTIKLA	J.M.	
SKV1	Stolna kutna veza s jednom rupom	Kom.	10
SKV2	Stolna kutna veza s dvije rupe	Kom.	10



OKOVI ZA KREVEETE

ŠIFRA ARTIKLA	OPIS ARTIKLA	J.M.	
KK100	Kutnik kreveta L-100mm	Kom	10
KK130	Kutnik kreveta L-130mm	Kom	10



ŠIFRA ARTIKLA	OPIS ARTIKLA	J.M.	
DO001	Dvokrevetni okov	Kom.	100



ŠIFRA ARTIKLA	OPIS ARTIKLA	J.M.	
DM613H	Dvonavojna matica , M6x13mm , 100/1	cet	45
DM815H	Dvonavojna matica , M8x15mm , 100/1	cet	20



ŠIFRA ARTIKLA	OPIS ARTIKLA	J.M.	
VM614	Vijak M6x14mm 100/1	cet	5



ŠIFRA ARTIKLA	OPIS ARTIKLA	J.M.	
---------------	--------------	------	---

PK1 Podesivi kutnik kreveta , LINEFIX Kom. 10

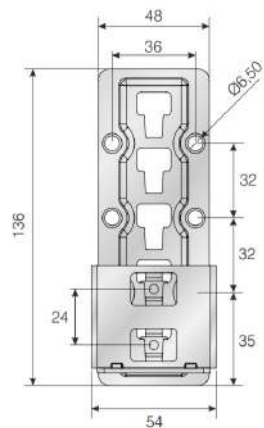

ŠIFRA ARTIKLA	OPIS ARTIKLA	J.M.	
---------------	--------------	------	---

KKP100 Kutnik kreveta sa postoljem , 100x100mm Kom. 50

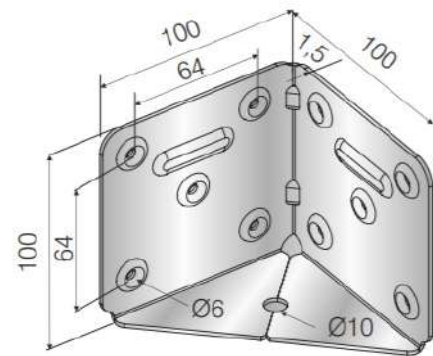

ŠIFRA ARTIKLA	OPIS ARTIKLA	J.M.	
---------------	--------------	------	---

NKP1 Noga za kutnik kreveta sa postoljem , h-200mm Kom. 10



Ručni alati i pribor



conq

ŠIFRA ARTIKLA	OPIS ARTIKLA	J.M.	
ABR35	Glodalo "FORSTNER", Ø35mm	Kom.	5



ŠIFRA ARTIKLA	OPIS ARTIKLA	J.M.	
ABR35G	Glodali, Ø35mm, sa graničnikom	Kom.	5



ŠIFRA ARTIKLA	OPIS ARTIKLA	J.M.	
KS4	Kutna stega, 4/1, set	Set	10

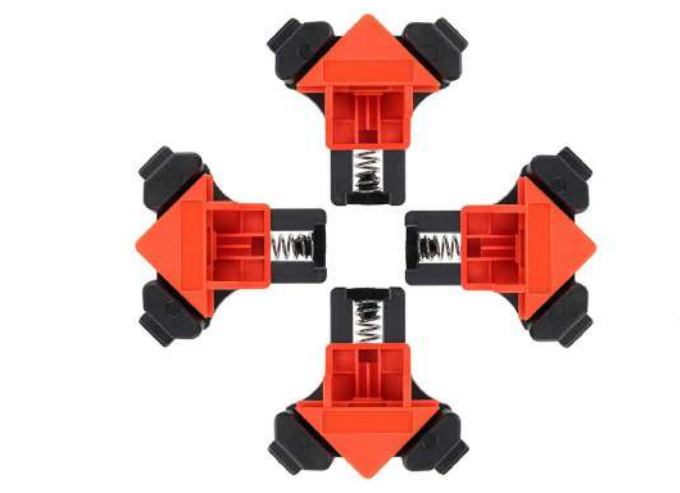

ŠIFRA ARTIKLA	OPIS ARTIKLA	J.M.	
KSM1	Metalna kutna stega	Kom.	5



ŠIFRA ARTIKLA	OPIS ARTIKLA	J.M.	
BV5710	Višestepeni borer, 5-7-10mm	Kom.	10



ŠIFRA ARTIKLA	OPIS ARTIKLA	J.M.	
BDU3	Borer fi3mm sa upuštanjem za glavu vijka	Kom.	5



ŠIFRA ARTIKLA	OPIS ARTIKLA	J.M.	
A2	Šablon za postavljanje spona fi35 mm, sa priborom	Set	10



ŠIFRA ARTIKLA	OPIS ARTIKLA	J.M.	
A5	Alat za postavljanje vodilica, magnetni prihvatnik	Kom.	5



ŠIFRA ARTIKLA	OPIS ARTIKLA	J.M.	
BDU5	Spiralno svrdlo za drvo, sa upuštanjem, 5mm	Kom.	5



ŠIFRA ARTIKLA	OPIS ARTIKLA	J.M.	
BDU3G	Borer fi3mm sa upuštanjem za glavu vijka i graničnikom	Kom.	5



ŠIFRA ARTIKLA	OPIS ARTIKLA	J.M.	
PS001	Pištalj za silikon	Kom.	10



ŠIFRA ARTIKLA	OPIS ARTIKLA	J.M.	
A3	Alat za postavljanje silikona	Kom.	10



ŠIFRA ARTIKLA	OPIS ARTIKLA	J.M.	
A6	Alat/Zakačka za postavljanje fronti	Kom.	20



ŠIFRA ARTIKLA	OPIS ARTIKLA	J.M.	
BS5	Brza stezaljka, 5"	Kom.	10



ŠIFRA ARTIKLA	OPIS ARTIKLA	J.M.	
KS350	Kutnik stolarski , 350mm	Kom.	5

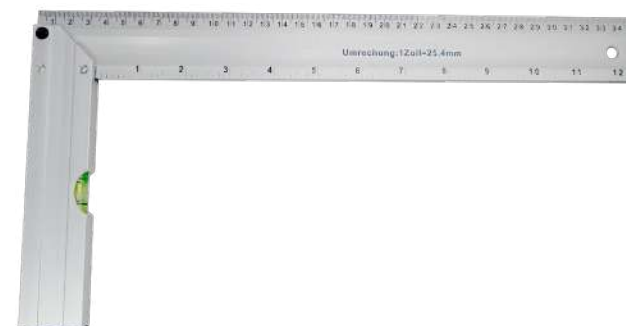

ŠIFRA ARTIKLA	OPIS ARTIKLA	J.M.	
VC300	Vinklo, CONT, 300mm	Kom.	12
VC400	Vinklo, CONT, 400mm	Kom.	12
VC500	Vinklo, CONT, 500mm	Kom.	12



ŠIFRA ARTIKLA	OPIS ARTIKLA	J.M.	
A4	Šablon za tiplanje	Kom.	10



ŠIFRA ARTIKLA	OPIS ARTIKLA	J.M.	
KAB01	Kutni adapter za aku bušilicu	Kom.	10



ŠIFRA ARTIKLA	OPIS ARTIKLA	J.M.	
M316	Metar , 3m , 16mm , blister pakiranje	Kom.	12
M519	Metar , 5m , 19mm , blister pakiranje	Kom.	12



ŠIFRA ARTIKLA	OPIS ARTIKLA	J.M.	
TS170	Trokut stolarski, 17cm	Kom.	5

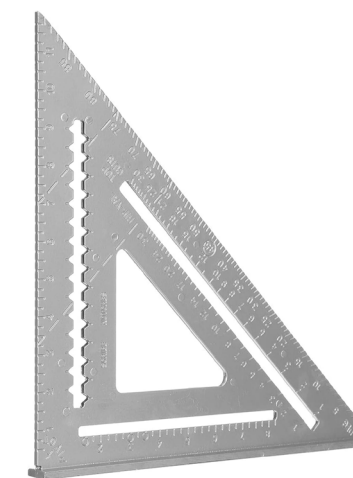

ŠIFRA ARTIKLA	OPIS ARTIKLA	J.M.	
A8	Alat za pravljenje fi8mm kapica od kant trake	Kom.	5



ŠIFRA ARTIKLA	OPIS ARTIKLA	J.M.	
A9	Alat/nož za skidanje viška kant trake	Kom.	5



ŠIFRA ARTIKLA	OPIS ARTIKLA	J.M.	
PR300	Podesivo ravnalo, 300mm	Kom.	5



ŠIFRA ARTIKLA	OPIS ARTIKLA	J.M.	
PMV01	Pomoćni alat za montažu visećih elemenata	Kom.	2



ŠIFRA ARTIKLA	OPIS ARTIKLA	J.M.	
ST150	Stega jednoručna , 150 mm	Kom.	20
ST300	Stega jednoručna , 300 mm	Kom.	20
ST600	Stega jednoručna , 600 mm	Kom.	20
ST900	Stega jednoručna , 900 mm	Kom.	20



ŠIFRA ARTIKLA	OPIS ARTIKLA	J.M.	
ST50150	Stega, 50x150mm	Kom.	10
ST80200	Stega, 80x200mm	Kom.	10



ŠIFRA ARTIKLA	OPIS ARTIKLA	J.M.	
KA13H	Kofer za alat, 13', CONAX	Kom.	1
KA16H	Kofer za alat, 16', CONAX	Kom.	1
KA19H	Kofer za alat, 19', CONAX	Kom.	1



ŠIFRA ARTIKLA	OPIS ARTIKLA	J.M.	
ST150D	Stega, DANMI, 150mm	Kom.	10
ST300D	Stega, DANMI, 300mm	Kom.	10
ST450D	Stega, DANMI, 450mm	Kom.	10



DANMI®

ŠIFRA ARTIKLA	OPIS ARTIKLA	J.M.	
LD300	Libela/Vaservaga, DANMI, 300mm	Kom.	1
LD600	Libela/Vaservaga, DANMI, 600mm	Kom.	1
LD1000	Libela/Vaservaga, DANMI, 1000mm	Kom.	1



DANMI®

ŠIFRA ARTIKLA	OPIS ARTIKLA	J.M.	
G300D	Gumeni čekić, 300g, DANMI	Kom.	10



DANMI®

ŠIFRA ARTIKLA	OPIS ARTIKLA	J.M.	
400112	DANMI Akumulatorska bušilica 12V/1.5Ah, 30Nm	Kom.	1

Kofer
Aku. mašina
Punjač
1.5Ah baterija (2x)



DANMI®

ŠIFRA ARTIKLA	OPIS ARTIKLA	J.M.	
KBR51	Kruna HSS za bušenje rupe, CONAX, 51mm	Kom.	1
KBR60	Kruna HSS za bušenje rupe, CONAX, 60mm	Kom.	1
KBR76	Kruna HSS za bušenje rupe, CONAX, 76mm	Kom.	1
KBR127	Kruna HSS za bušenje rupe, CONAX, 127mm	Kom.	1
KBR140	Kruna HSS za bušenje rupe, CONAX, 140mm	Kom.	1



ŠIFRA ARTIKLA	OPIS ARTIKLA	J.M.	
400220	DANMI Akumulatorski odvijač, 20V/1.5Ah, 45Nm	Kom.	1

Kofer
Aku. mašina
Punjač
1.5Ah baterija (2x)



DANMI®

ŠIFRA ARTIKLA	OPIS ARTIKLA	J.M.	
ADKBR	SDS Adapter za krune	Kom.	1



CONAX



ŠIFRA ARTIKLA	OPIS ARTIKLA	J.M.	
13262	Olovka za obilježavanje, 150mm, FESTA	Kom.	1
13263	Rezervni grafitni umeci za 13262, 6/1, FESTA	Set	1



ŠIFRA ARTIKLA	OPIS ARTIKLA	J.M.	
13279	Automatska stolarska olovka sa umetcima, FESTA	Kom.	1



ŠIFRA ARTIKLA	OPIS ARTIKLA	J.M.	
RN01	Rukavice , narančaste , GRIP	Kom.	12



ŠIFRA ARTIKLA	OPIS ARTIKLA	J.M.	
RR02	Rukavice, radne, A-858	Kom.	12



ŠIFRA ARTIKLA	OPIS ARTIKLA	J.M.	
S1D	Skalpel, DANMI, Mod.1, 18mm	Kom.	12



ŠIFRA ARTIKLA	OPIS ARTIKLA	J.M.	
S2D	Skalpel, DANMI, Mod.2, 18mm	Kom.	12



ŠIFRA ARTIKLA	OPIS ARTIKLA	J.M.	
PK25	Produžni kabal, 25m	Kom.	1
PK15	Produžni kabal, 15m	Kom.	1



ŠIFRA ARTIKLA	OPIS ARTIKLA	J.M.	
Z1025	Zatezač 10m, 2,5t	Kom.	1
Z510	Zatezač 5m, 1t	Kom.	1



ŠIFRA ARTIKLA	OPIS ARTIKLA	J.M.	
NRSD	Rezervni noževi za skalpel, DANMI, 18mm	Kom.	12



ŠIFRA ARTIKLA	OPIS ARTIKLA	J.M.	
S3	Stezaljke, 3/1	Kom.	1



DANMI®

CONGOX

ŠIFRA ARTIKLA	OPIS ARTIKLA	J.M.	
A50G	Ljepilo dvokomponentno 50g / 200ml - INTERBOND	Kom.	40
A100G	Ljepilo dvokomponentno 100g / 400ml - INTERBOND	Kom.	25
A125G	Ljepilo dvokomponentno 125g / 500ml - INTERBOND	Kom.	24



ŠIFRA ARTIKLA	OPIS ARTIKLA	J.M.	
LD3600	Ljepilo za drvo D3, 600gr - STS	Kom.	25



ŠIFRA ARTIKLA	OPIS ARTIKLA	J.M.	
SF18250	Streč folija 18 mikrona, 250m	Kom.	6



ŠIFRA ARTIKLA	OPIS ARTIKLA	J.M.	
SFN250	Streč folija NANO/MINI, 250m	Kom.	6



ŠIFRA ARTIKLA	OPIS ARTIKLA	J.M.	
OT195	Obostrano ljepljiva, adezivna traka 19mm x 5m	Kom.	100



ŠIFRA ARTIKLA	OPIS ARTIKLA	J.M.	
SS5066	Traka za ljepljenje, 48mmx66m, smeđa	Kom.	72



ŠIFRA ARTIKLA	OPIS ARTIKLA	J.M.	
KT1950	Krep traka ,19mmx50m	Kom.	12
KT5050	Krep traka, 50mmx50m	Kom.	6



ŠIFRA ARTIKLA	OPIS ARTIKLA	J.M.	
PC6020BL	Samoljepljivi silikonski ublaživač, 20x20x3mm, 50/1, crna boja	Kom.	25



ŠIFRA ARTIKLA	OPIS ARTIKLA	J.M.	
PC6035BL	Samoljepljivi silikonski ublaživač, 35x35x3mm, 18/1, crna boja	Kom.	25



ŠIFRA ARTIKLA	OPIS ARTIKLA	J.M.	
PC6120BL	Samoljepljivi silikonski ublaživač, f20x3mm, 48/1, crna boja	Kom.	25



ŠIFRA ARTIKLA	OPIS ARTIKLA	J.M.	
PC6140BL	Samoljepljivi silikonski ublaživač, f40x3mm, 12/1, crna boja	Kom.	25



FILCEVI I PODMETAČI

ŠIFRA ARTIKLA	OPIS ARTIKLA	J.M.	
---------------	--------------	------	---

PC6220BL Samoljepljivi filc, 20x20x2.5mm, 50/1, crna boja Kom. 25



ŠIFRA ARTIKLA	OPIS ARTIKLA	J.M.	
---------------	--------------	------	---

PC6235BL Samoljepljivi filc, 35x35x2.5mm, 18/1, crna boja Kom. 25



ŠIFRA ARTIKLA	OPIS ARTIKLA	J.M.	
---------------	--------------	------	---

PC6320BL Samoljepljivi filc, fi20x2.5mm, 40/1, crna boja Kom. 25



ŠIFRA ARTIKLA	OPIS ARTIKLA	J.M.	
---------------	--------------	------	---

PC6350BL Samoljepljivi filc, fi50x2.5mm, 8/1, crna boja Kom. 25



ŠIFRA ARTIKLA	OPIS ARTIKLA	J.M.	
---------------	--------------	------	---

PC2871BL Samoljepljivi filc, 22x8x2mm, 30/1, crna boja Kom. 25



ŠIFRA ARTIKLA	OPIS ARTIKLA	J.M.	
---------------	--------------	------	---

PC2850 Samoljepljivi silikonski ublaživač, fi10x1.6mm, 50/1, transparentni Kom. 25

PC2851 Samoljepljivi silikonski ublaživač, fi9x2mm, 50/1, transparentni Kom. 25



Akustični dekorativni zidni paneli



Zvučna izolacija



Vatrootporni panel



➤ Dimenzije ploče: 2800 x 600 x 18mm

➤ Debljina filca: 8mm

➤ Debljina MDF letvica: 10mm

➤ Broj letvica(1 panel): 14 letvica



BIJELI HRAST



SONOMA



HRAST



ORAH



RUSTIK



BETON



Kontakt podaci

Contego d.o.o. - Centrala

Divjak bb info@contego.ba
72250 Vitez +387 30 719 100

Računovodstvo i financije

racunovodstvo@contego.ba
+387 30 719 102

Komercijala nabave i prodaje

nabava@contego.ba
import@contego.ba
veleprodaja@contego.ba
+387 30 719 102

Marketing

marketing@contego.ba

Krojne liste - Vitez

krojneliste1@contego.ba
krojneliste2@contego.ba
krojneliste3@contego.ba

Banja Luka

Put srpskih branilaca 174,
76000 Banja Luka

banjaluka@contego.ba

+387 51 928 546

Tuzla

Šićki brod bb,
75000 Tuzla

tuzla@contego.ba

+387 35 216 197

Mostar

Bišće polje bb,
88000 Mostar

mostar@contego.ba

+387 36 283 125

Cazin

Klupe bb, Šepići,
77220 Cazin

cazin@contego.ba

+387 61 888 728

Karijera u Contego?

posao@contego.ba

Contego d.o.o. zadržava prava na promjene podataka bez prethodnih obavještenja.
Slike artikala mogu odstupati od stvarnog izgleda. Zadržavamo prava na moguće pogreške.
Nije dozvoljena objava, uređivanje i prerada objavljenih materijala i slika bez suglasnosti izdavača.

2024 © Contego d.o.o. - Sva prava zadržana

CONTEGO

www.contego.ba

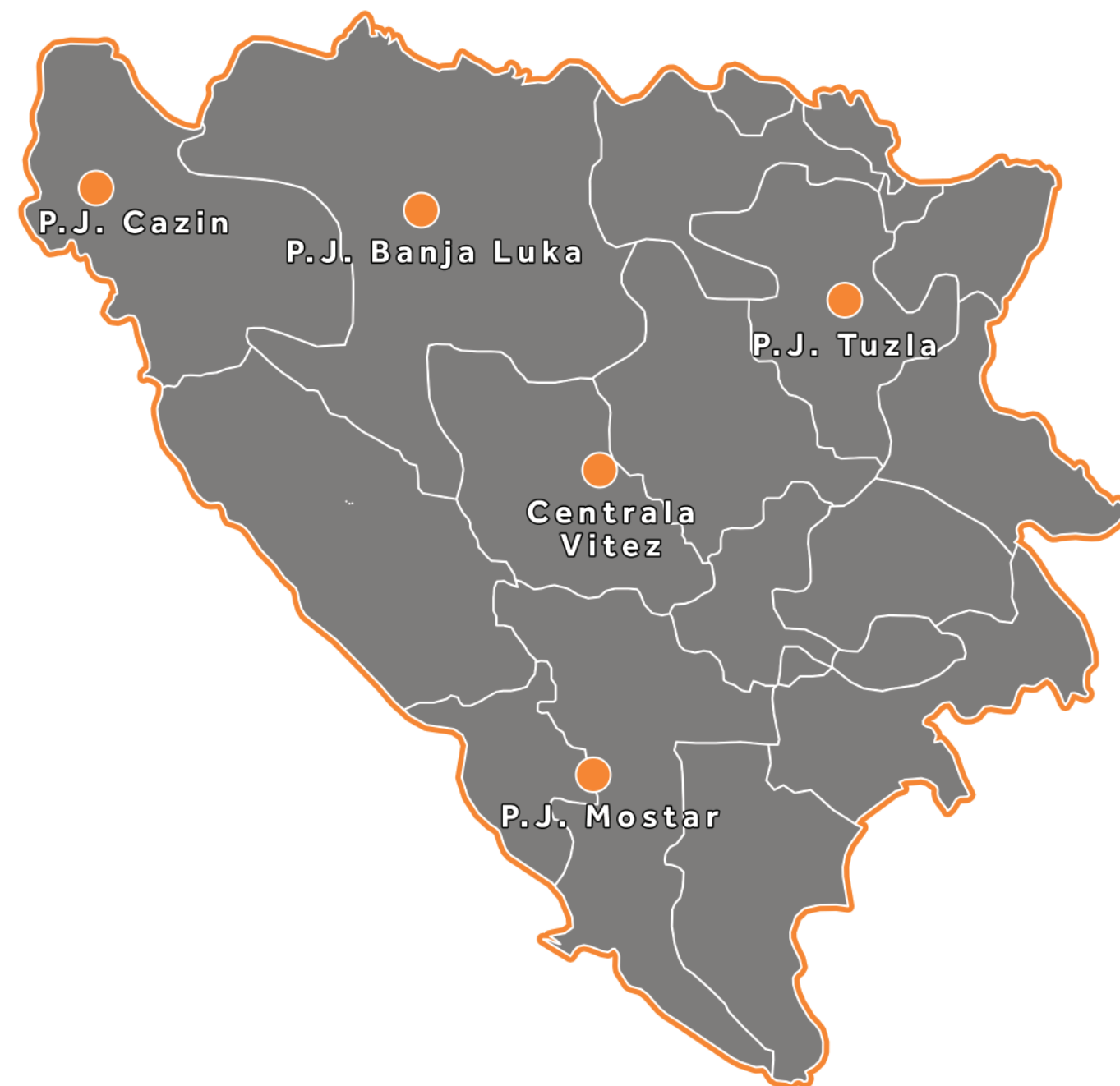

Pružamo brze i precizne isporuke reznih naloga uz uslugu kojoj možete vjerovati. Naš cilj je osigurati vaše zadovoljstvo i isporuku reznih naloga, kao i okova za namještaj u rekordnom vremenu, omogućujući vam da nastavite svoje poslovanje bez ikakvih prepreka.

S ponosom ističemo da smo prisutni diljem naše države s čak 5 poslovnih jedinica i drvnim centrom. Bez obzira na vašu lokaciju, naše poslovnice su tu da vam omoguće jednostavno preuzimanje narudžbi i upoznavanje s našim bogatim asortimanom.

Naš tim stručnjaka vam stoji na raspolaganju!

Sve za namještaj po mjeri!

Inspirirajte se
i stvorimo dom
Vaših snova...

CONTEGO

NTTEG

CO
